



Home Audio System

Operating Instructions

Getting Started

Disc/USB Playback

USB Transfer

Tuner

BLUETOOTH

Network

Gesture Control

Sound Adjustment

Other Operations

Additional Information

WARNING

To reduce the risk of fire, do not cover the ventilation opening of the appliance with newspapers, tablecloths, curtains, etc.

Do not expose the appliance to naked flame sources (for example, lighted candles).

To reduce the risk of fire or electric shock, do not expose this appliance to dripping or splashing, and do not place objects filled with liquids, such as vases, on the appliance.

As the main plug is used to disconnect the unit from the mains, connect the unit to an easily accessible AC outlet. Should you notice an abnormality in the unit, disconnect the main plug from the AC outlet immediately.

Do not install the appliance in a confined space, such as a bookcase or built-in cabinet.

Do not expose batteries or appliances with battery-installed to excessive heat, such as sunshine and fire.

The unit is not disconnected from the mains as long as it is connected to the AC outlet, even if the unit itself has been turned off.

Indoor use only.

For product with CE marking

The validity of the CE marking is restricted to only those countries where it is legally enforced, mainly in the countries EEA (European Economic Area) and Switzerland.

CAUTION

The use of optical instruments with this product will increase eye hazard.

Risk of explosion if the battery is replaced by an incorrect type.

For customers in Europe

CLASS 1 LASER PRODUCT
LASER KLASSE 1
LUOKAN 1 LASERLÄITE
KLASS 1 LASERAPPARAT

This product is classified CLASS 1 LASER product by IEC 60825-1:2007 and IEC 60825-1:2014. This marking is located on the rear exterior.

Disposal of waste batteries and electrical and electronic equipment (applicable in the European Union and other countries with separate collection systems)



This symbol on the product, the battery or on the packaging indicates that the product and the battery shall not be treated as household waste. On certain batteries this symbol might be used in combination with a chemical symbol. The chemical symbol for lead (Pb) is added if the battery contains more than 0.004% lead. By ensuring that these products and batteries are disposed of correctly, you will help to prevent potentially negative consequences for the environment and human health which could be caused by inappropriate waste handling. The recycling of the materials will help to conserve natural resources. In case of products that for safety, performance or data integrity reasons require a permanent connection with an incorporated battery, this battery should be replaced by qualified service staff only. To ensure that the battery and the electrical and electronic equipment will be treated properly, hand over these products at end-of-life to the appropriate collection point for the

recycling of electrical and electronic equipment. For all other batteries, please view the section on how to remove the battery from the product safely. Hand the battery over to the appropriate collection point for the recycling of waste batteries. For more detailed information about recycling of this product or battery, please contact your local Civic Office, your household waste disposal service or the shop where you purchased the product or battery.

Notice for customers: the following information is only applicable to equipment sold in countries applying EU directives.

This product has been manufactured by or on behalf of Sony Corporation. EU Importer: Sony Europe B.V. Inquiries to the EU Importer or related to product compliance in Europe should be sent to the manufacturer's authorized representative, Sony Belgium, bijkantoor van Sony Europe B.V., Da Vincilaan 7-D1, 1930 Zaventem, Belgium.

Hereby, Sony Corporation declares that this equipment is in compliance with Directive 2014/53/EU. The full text of the EU declaration of conformity is available at the following internet address:

<http://www.compliance.sony.de/>



For this radio equipment, the following restrictions on putting into service or of requirements for authorisation of use apply in BE, BG, CZ, DK, DE, EE, IE, EL, ES, FR, HR, IT, CY, LV, LT, LU, HU, MT, NL, AT, PL, PT, RO, SI, SK, FI, SE, UK, IS, LI, NO, CH, AL, BA, MK, MD, RS, ME, XK, TR: 5150 - 5350 MHz band is restricted to indoor operations only.

This equipment has been tested and found to comply with the limits set out in the EMC regulation using a connection cable shorter than 3 meters.

This system is designed to be used for the following purposes:

- Playing back music/video sources on discs or USB devices
- Transferring music to USB devices
- Listening to radio stations
- Listening to TV sound
- Playing back music sources on BLUETOOTH devices
- Enjoying social gatherings with the "Party Chain" function
- Streaming music through network connection

For customers in Australia and New Zealand

This equipment should be installed and operated with at least 20 cm and more between the radiator and person's body (excluding extremities: hands, wrists, feet and ankles).

For customers in Australia and India



Disposal of Old Electrical & Electronic Equipment (Applicable in the European Union and other European countries with separate collection systems)

For customers in Singapore

Complies with
IMDA Standards
DB00353

For customers in the United Arab Emirates

CLASS 1 LASER PRODUCT

This appliance is classified as a CLASS 1 LASER product under IEC 60825-1:2007. This marking is located on the rear exterior.

**TRA
REGISTERED No:
ER55363/17
DEALER No:
DA0096946/12**

License and Trademark Notice

- **DVD** is a trademark of DVD Format/ Logo Licensing Corporation.
- "DVD+RW", "DVD-RW", "DVD+R", "DVD-R", "DVD VIDEO", and the "CD" logos are trademarks.
- WALKMAN® and WALKMAN® logo are registered trademarks of Sony Corporation.
- MPEG Layer-3 audio coding technology and patents licensed from Fraunhofer IIS and Thomson.
- Windows Media is either a registered trademark or trademark of Microsoft Corporation in the United States and/or other countries.
- This product is protected by certain intellectual property rights of Microsoft Corporation. Use or distribution of such technology outside of this product is prohibited without a license from Microsoft or an authorized Microsoft subsidiary.
- This system incorporates Dolby* Digital.
 - * Manufactured under license from Dolby Laboratories. Dolby, Dolby Audio, and the double-D symbol are trademarks of Dolby Laboratories.
- This system incorporates High-Definition Multimedia Interface (HDMI™) technology. The terms HDMI and HDMI High-Definition Multimedia Interface, and the HDMI Logo are trademarks or registered trademarks of HDMI Licensing LLC in the United States and other countries.
- "BRAVIA" is a trademark of Sony Corporation.
- LDAC™ and LDAC logo are trademarks of Sony Corporation.

- The BLUETOOTH® word mark and logos are registered trademarks owned by Bluetooth SIG, Inc. and any use of such marks by Sony Corporation is under license. Other trademarks and trade names are those of their respective owners.
- The N-Mark is a trademark or registered trademark of NFC Forum, Inc. in the United States and in other countries.
- Android™ is a trademark of Google Inc.
- Google Play™ is a trademark of Google Inc.
- Android, Google Play, the Google Play logo, and Chromecast are trademarks of Google Inc.
- Apple, the Apple logo, iPhone, and iPod touch are trademarks of Apple Inc., registered in the U.S. and other countries. App Store is a service mark of Apple Inc.
- “Made for iPod,” and “Made for iPhone” mean that an electronic accessory has been designed to connect specifically to iPod or iPhone, respectively, and has been certified by the developer to meet Apple performance standards. Apple is not responsible for the operation of this device or its compliance with safety and regulatory standards. Please note that the use of this accessory with iPod or iPhone may affect wireless performance.
- Wi-Fi®, Wi-Fi Protected Access® and Wi-Fi Alliance® are registered trademarks of Wi-Fi Alliance®.
- Wi-Fi CERTIFIED™, WPA™, WPA2™ and Wi-Fi Protected Setup™ are trademarks of Wi-Fi Alliance®.
- DLNA™, the DLNA Logo and DLNA CERTIFIED™ are trademarks, service marks, or certification marks of the Digital Living Network Alliance.
- AOSS is a trademark of BUFFALO INC.
- Spotify and Spotify logos are trademarks of the Spotify Group. The Spotify Software is subject to third party licenses found here: <https://www.spotify.com/connect/third-party-licenses>
- ClearAudio+ and **ClearAudio+** are trademarks of Sony Corporation.
- “Xperia” and “Xperia Tablet” are trademarks of Sony Mobile Communications AB.
- THIS PRODUCT IS LICENSED UNDER THE MPEG-4 VISUAL PATENT PORTFOLIO LICENSE FOR THE PERSONAL AND NON-COMMERCIAL USE OF A CONSUMER FOR
 - (i) ENCODING VIDEO IN COMPLIANCE WITH THE MPEG-4 VISUAL STANDARD (“MPEG-4 VIDEO”)

AND/OR

 - (ii) DECODING MPEG-4 VIDEO THAT WAS ENCODED BY A CONSUMER ENGAGED IN A PERSONAL AND NON-COMMERCIAL ACTIVITY AND/OR WAS OBTAINED FROM A VIDEO PROVIDER LICENSED TO PROVIDE MPEG-4 VIDEO.

NO LICENSE IS GRANTED OR SHALL BE IMPLIED FOR ANY OTHER USE. ADDITIONAL INFORMATION INCLUDING THAT RELATING TO PROMOTIONAL, INTERNAL AND COMMERCIAL USES AND LICENSING MAY BE OBTAINED FROM MPEG LA, L.L.C.
[HTTP://WWW.MPEGLA.COM](http://WWW.MPEGLA.COM)
- All other trademarks are trademarks of their respective owners.
- In this manual, ™ and ® marks are not specified.

About this manual

- This manual mainly explains operations using the remote control, but the same operations can also be performed using the keys on the touch panel of the unit having the same or similar names.
- Icons, such as **DVD-V**, listed at the top of each explanation indicate the type of media that can be used with the function being explained.
- Some illustrations are presented as conceptual drawings, and may be different from the actual products.
- The items displayed on the TV screen may vary depending on the area.
- The default setting is underlined.
- The text enclosed in bracket ([--]) appears on the TV screen, and the text enclosed in double quotation mark ("--") appears on the display.

Table of Contents

About this manual	6
Unpacking.....	9
Playable discs or files on discs/USB device	9
Websites for compatible devices	12
Guide to parts and controls	13

Getting Started

Assembling the unit.....	20
Hooking up the system securely.....	21
Deactivating the demonstration	23
Inserting batteries	23
Connecting the TV	25
Carrying the unit	27
Changing the color system.....	28
Performing the quick setup	28
Changing the display mode.....	29

Disc/USB Playback

Before using the USB device.....	30
Basic playback	30
Other playback operations ...	31
Using play mode	34

Restricting playback of the disc (Parental Control).....	35
Viewing information of a disc and USB device	36
Using the Setup Menu	37

USB Transfer

Before using the USB device.....	41
Transferring music	41

Tuner

Listening to the radio.....	44
-----------------------------	----

BLUETOOTH

About the BLUETOOTH wireless technology.....	45
Pairing this system with a BLUETOOTH device	45
Listening to music on a BLUETOOTH device	46
One Touch BLUETOOTH Connection by NFC	47
Setting the BLUETOOTH audio codecs.....	48

Network

- Selecting the method of network connection..... 49
- Connecting with a computer 49
- Listening to the same music from the multiple speakers...51
- Listening to an Internet music service (Chromecast built-in)51
- Spotify Connect 52

Gesture Control

- Enjoying the Gesture Control 53
- Using the Gesture Control during playback 54
- Creating a party atmosphere (DJ Effect)..... 54
- Using the Gesture Control during Karaoke function 55

Sound Adjustment

- Adjusting the sound 56
- Selecting the Virtual Football mode..... 56
- Adjusting the subwoofer level..... 57
- Creating your own sound effect..... 57

Other Operations

- Controlling the system using a smartphone or tablet (SongPal)..... 57
- Getting frenzied parties with the “Fiestable” app..... 58
- Using the Control for HDMI function..... 58
- Using the Party Chain function.....61
- Singing along: Karaoke..... 64
- Enjoying sound from a guitar..... 65
- Enjoying music with the Party Light and Speaker Light..... 66
- Using the Sleep Timer..... 66
- Using the Voice Guidance.... 66
- Using optional equipment... 67
- Deactivating the touch panel on the unit (Child Lock)..... 67
- Setting the automatic standby function..... 67
- Setting the BLUETOOTH/ Network standby mode 68
- Turning on or off the BLUETOOTH/Wi-Fi signal..... 68
- Updating the software..... 69

Additional Information

- Troubleshooting 71
- Precautions 82
- Specifications..... 86
- Language code list90

Unpacking

- This unit (MHC-V90DW) (1) (composed of the satellite unit and the subwoofer unit)
- Mounting screws (M5 × 30) (4)
- Remote control (1)
- R03 (size AAA) batteries (2)
- FM lead antenna (1)
- AC plug adaptor (1)*

This plug adaptor is not for the use in Chile, Paraguay and Uruguay. Use this plug adaptor in the countries where it is necessary.

- AC power cord (mains lead) (1)*
For customers in the UK, Ireland, Malta, and Cyprus:

—Use the AC power cord (mains lead) (A).

—For safety reasons, the AC power cord (mains lead) (B) is not intended for the above countries/regions and shall therefore not be used there.

For customers in other countries/regions:

—Use the AC power cord (mains lead) (B).

(A)

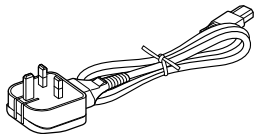

(B)

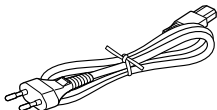

* Depending on your region/country.

Note

When unpacking the carton, be sure that two people handle the unit. Dropping the unit may cause personal injury and/or property damage.

Playable discs or files on discs/USB device

Playable discs

- DVD VIDEO
- DVD-R/DVD-RW in DVD VIDEO format or video mode
- DVD+R/DVD+RW in DVD VIDEO format
- VIDEO CD (Ver. 1.0, 1.1, and 2.0 discs)
- Super VCD
- CD-R/CD-RW/CD-ROM in VIDEO CD format or super VCD format
- AUDIO CD
- CD-R/CD-RW in AUDIO CD format

Playable files on discs

- Music:
MP3 files (.mp3)*1*2
- Video:
MPEG4 files (.mp4/.m4v)*2*3, Xvid files (.avi)

Playable files on USB device

- Music:
MP3 files (.mp3)*1*2, WMA files (.wma)*2, AAC files (.m4a/.mp4/.3gp)*2, WAV files (.wav)*2, AIFF files (.aiff)*2, FLAC files (.flac)*2, ALAC files (.alac)*2, DSD (.dsf/.dff)*2
- Video:
MPEG4 files (.mp4/.m4v)*2*3, Xvid files (.avi)

Note

- The discs must be in the following format:
 - CD-ROM/-R/-RW in DATA CD format that contains the MP3*1*2, MPEG4*2*3 and Xvid files, and conforms to ISO 9660*4 Level 1/Level 2 or Joliet (extended format).

- DVD-ROM/-R/-RW/+R/+RW in DATA DVD format that contains the MP3^{*1*2}, MPEG4^{*2*3} and Xvid files, and conforms to UDF (Universal Disk Format).
- The system will attempt to play back any data with the extensions above, even if it is not in the supported format. Playing this data may generate a loud noise which could damage your speaker system.
- ^{*1} MP3 (MPEG 1 Audio Layer 3) is a standard format defined by ISO/ MPEG for compressed audio data. MP3 files must be in MPEG 1 Audio Layer 3 format.
- ^{*2} Files with copyright protection (Digital Rights Management) cannot be played back by the system.
- ^{*3} MPEG4 files must be recorded in MP4 file format. Supported video codec and audio codec are as follows:
 - Video codec: MPEG4 Simple Profile (AVC is not supported.)
 - Audio codec: AAC-LC (HE-AAC is not supported.)
- ^{*4} A logical format of files and folders on CD-ROMs, defined by ISO (International Organization for Standardization).

Discs/files that cannot be played back

- You cannot play back the following discs
 - BDs (Blu-ray Discs)
 - CD-ROMs recorded in PHOTO CD format
 - Data part of CD-Extra or Mixed Mode CDs*
 - CD Graphics disc
 - Super Audio CDs
 - DVD Audio
 - DATA CD/DATA DVD that is created in Packet Write format
 - DVD-RAM
 - DATA CD/DATA DVD which has not been correctly finalized

- CPRM (Content Protection for Recordable Media) compatible DVD-R/-RW recorded in Copy-Once programs
- A disc that has a non-standard shape (e.g., heart, square, star)
- A disc that has adhesive tape, paper, or a sticker attached to it
- You cannot play back the following files
 - The video files which is larger than 720 (width) × 576 (height) pixels.
 - The video files with a high width to length ratio.
 - A WMA file in WMA DRM, WMA Lossless, or WMA PRO format.
 - An AAC file in AAC DRM or AAC Lossless format.
 - The AAC files which is encoded at 96 kHz.
 - Files that are encrypted or protected by passwords.
 - Files with DRM (Digital Rights Management) copyright protection.
 - Some Xvid files that are longer than 2 hours.
- The MP3 PRO audio file can be played back as MP3 file.
- The system may not play back an Xvid file when the file has been combined from two or more Xvid files.
- * Mixed Mode CD: This format records data on the first track and audio (AUDIO CD data) on the second and subsequent tracks of a session.

Notes on CD-R/-RW and DVD-R/-RW/+R/+RW

- In some cases, a CD-R/-RW and DVD-R/-RW/+R/+RW cannot be played back on this system due to the recording quality or physical condition of the disc, or the characteristics of the recording device and authoring software. For more information, refer to the operating instructions of the recording device.
- Some playback functions may not work with some DVD+Rs/+RWs, even if they have been correctly finalized. In this case, view the disc by normal playback.

Notes on discs

- This product is designed to play back discs that conform to the Compact Disc (CD) standard.
- DualDisc and some music discs encoded with copyright protection technologies do not conform to the CD standard. Therefore, these discs may not be compatible with this product.

Note on multisession disc

This system can play back continuous sessions on a disc when they are recorded in the same format as the first session. However, the playback is not guaranteed.

Note on DVD VIDEO and VIDEO CD playback operations

Some playback operations for a DVD VIDEO or VIDEO CD may be intentionally restricted by software producers. Therefore, some playback features may not be available. Be sure to read the operating instructions of the DVD VIDEO or VIDEO CD.

Notes on playable files

- Playback may take a longer time to start when:
 - a DATA CD/DATA DVD/USB device is recorded with a complicated tree structure.
 - the audio files or video files in another folder have just been played back.
- The system can play back a DATA CD/DATA DVD or video files on a USB device in the following conditions:
 - up to a depth of 8 folders
 - up to 300 folders
 - up to 999 files in a disc
 - up to 2,000 files in a USB device
 - up to 650 files in a folderThe system can play back audio files on a USB device in the following conditions:
 - up to a depth of 8 folders
 - up to 998 files and sub-folders in a folderThese numbers may vary depending on the file or folder configuration.
- Folders that have no audio files or video files are skipped.
- Files transferred by a device such as a computer may not be played back in the order in which they were transferred.
- The playback order may not be applicable depending on the software used for creating the audio file or video file.
- Compatibility with all encoding/writing software of the supported formats, recording devices, and recording media cannot be guaranteed.
- Depending on the Xvid file, the picture may be unclear or the sound may skip.

Notes about USB devices

- This system is not guaranteed to operate with all USB devices.
- Although there are a variety of complex functions for USB devices, the playable contents of USB devices connected to the system are music and video contents only. For details, refer to the operating instructions of the USB device.
- When a USB device is inserted, the system reads all the files on the USB device. If there are many folders or files on the USB device, it may take a long time to finish reading the USB device.
- Do not connect the system and the USB device through a USB hub.
- With some connected USB devices, there may be a delay before an operation is performed by this system.
- The playback order for the system may differ from the playback order of the connected USB device.
- Before using a USB device, make sure that no virus-ridden files are on the USB device.

Region code

Your system has a region code and will only play back a DVD VIDEO labeled with an identical region code or .

Websites for compatible devices

Check the websites below for the latest information about compatible USB and BLUETOOTH devices.

For customers in Latin America:

<<http://esupport.sony.com/LA>>

For customers in Europe and Russia:

<<http://www.sony.eu/support>>

For customers in other countries/regions:

<<http://www.sony-asia.com/support>>

Compatible iPhone/iPod models

The compatible iPhone/iPod models are as follows. Update your iPhone/iPod with the latest software before using with the system.

BLUETOOTH technology works with:

- iPhone 7 Plus
- iPhone 7
- iPhone SE
- iPhone 6s Plus
- iPhone 6s
- iPhone 6 Plus
- iPhone 6
- iPhone 5s
- iPhone 5c
- iPhone 5
- iPhone 4s
- iPod touch (6th generation)
- iPod touch (5th generation)

Guide to parts and controls

Unit (Front):

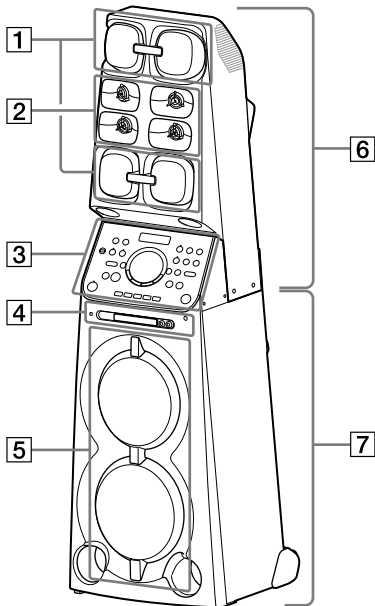

- 1 Midrange speaker × 4
(Speaker light function equipped*)
- 2 Tweeter × 4
- 3 Touch panel (page 14)
- 4 Disc tray and its surroundings
(page 14)
- 5 Subwoofer × 2
(Speaker light function equipped*)
- 6 Satellite unit

Unit (Rear):

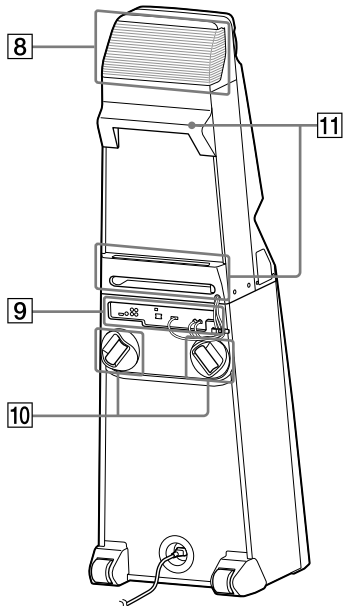

- 7 Subwoofer unit
- 8 Spread sound generator
Spreads sound around the rear
of the unit.
- 9 Connector panel (page 21)
- 10 Party lights (left/right)*
(page 66)
- 11 Handles for holding or
carrying the unit

* Do not look directly at the light-emitting parts when the Speaker Light and Party Light are turned on.

Touch panel:

You can lock the keys except ψ (power) on the unit to prevent them from being operated by mistake (page 67).

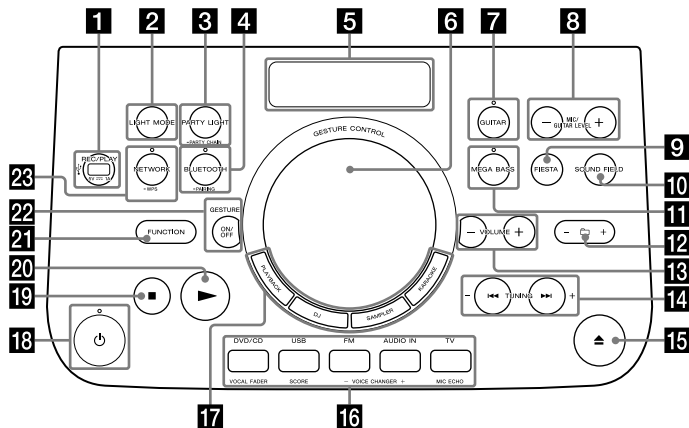

Disc tray area:

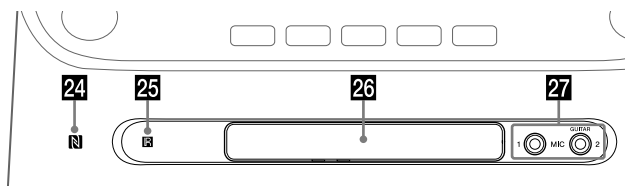

1 ψ (USB) (REC/PLAY) port
Use to connect a USB device.
This port can be used for both
playback and music transfer.

2 LIGHT MODE key (page 66)

3 PARTY LIGHT key (page 66)
– PARTY CHAIN key
(page 63)



4 BLUETOOTH indicator
(page 45)

BLUETOOTH key

Touch to select the BLUETOOTH
function.

– PAIRING key

Touch and hold to activate
BLUETOOTH pairing during the
BLUETOOTH function.

- 5** Display
- 6** GESTURE CONTROL sensor (page 53, 54, 55)
- 7** GUITAR indicator
Lights up when guitar mode is turned on.
GUITAR key (page 65)
- 8** MIC/GUITAR LEVEL +/- key (page 64, 65)
- 9** FIESTA key (page 56)
- 10** SOUND FIELD key (page 56)
- 11** MEGA BASS indicator
Lights up when MEGA BASS sound effect is selected.
MEGA BASS key (page 56)
- 12**  (folder) +/- key
Touch to select a folder on a data disc or a USB device.
- 13** VOLUME +/- key
Touch to adjust the volume.
- 14**  (go backward/go forward) key
Touch to select a track or file.
TUNING +/- key (page 44)
- 15**  (open/close) key
Touch to open or close the disc tray.
- 16** Direct function key (DVD/CD, USB, FM, AUDIO IN, TV)
To use this key, touch PLAYBACK (**17**), then the function key you want.
VOCAL FADER key (page 64)
SCORE key (page 65)
VOICE CHANGER +/- key (page 65)
MIC ECHO key (page 64)
- 17** PLAYBACK key (page 54)
DJ key (page 54)
SAMPLER key (page 54)
KARAOKE key (page 55)
- 18** Power indicator
Indicates the current status of the system:
Lights off: The system is in standby mode and BLUETOOTH/Network standby mode is set to off.
Lights up:
— Orange: The system is in standby mode and BLUETOOTH/Network standby mode is set to on.
— Green: The system is turned on.
Flashes:
— Green: The system is in the midst of turning on or entering standby mode.
— Red: The system detects an abnormality that cannot be displayed with an error message.

(power) button

Press to turn on the system, or set it to standby mode.

19 ■ (stop) key

Touch to stop playback. When touched twice, resume playback can be canceled.

Touch to stop transfer during music transfer.

Touch to stop the built-in sound demonstration.

20 ► (play) key

Touch to start playback.

Touch and hold ► for more than 2 seconds, the built-in sound demonstration will be played back.

Touch ■ to stop the demonstration.

21 FUNCTION key

Touch to select a function.

22 GESTURE ON/OFF key (page 53, 54, 55)

23 NETWORK indicator

Indicates the current status of the system:

Lights off: The system is in standby mode.

Lights up:

- White: The network connection is established.
- Green: The system is connected to Spotify.
- Blue: The system is connected to a music service via Chromecast built-in.

Flashes:

- White: While connecting to network.

NETWORK key

Touch to select NETWORK function.

WPS (Wi-Fi Protected Setup™) key (page 49)

Touch and hold to set up a Wi-Fi network.

24 (N-Mark) (page 47)

25 Remote control sensor () (page 24)

26 Disc tray

27 MIC1 jack

Use to connect the microphone.

MIC2/GUITAR jack

Use to connect the microphone or guitar.

Remote control:

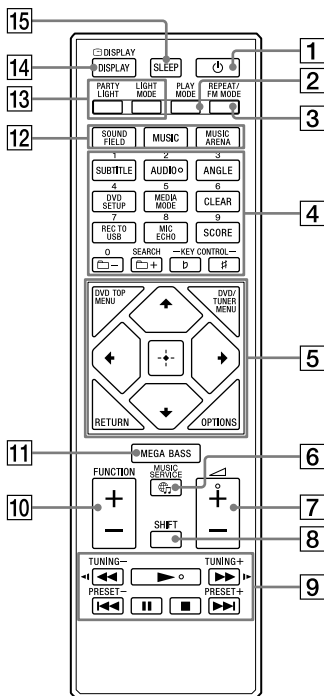

- 1** **⏻ (power) button**
Press to turn on the system, or sets it to standby mode.
- 2** **▶ (PLAY MODE) button (page 34, 42)**
- 3** **⏮ (REPEAT/FM MODE) button (page 34, 44)**

- 4** **Numeric (0 – 9) buttons*1*2**
 - Press to select a track, chapter or file with its item number.
 - Press to enter numbers or values.

SUBTITLE button (page 32)

AUDIO*2 button (page 32, 36)

ANGLE button (page 32)

DVD SETUP button (page 37)

MEDIA MODE button (page 30)

Press to select the media to be played back on a data disc or USB device.

CLEAR button (page 32)

REC TO USB tuning (page 42)

Press to transfer music to the USB device connected to the ψ (USB) port.

MIC ECHO button (page 64)

SCORE button (page 65)

Ⓛ (folder) +/-

Press to select a folder on a data disc or a USB device.

SEARCH button (page 31, 32)

KEY CONTROL $b/\#$ button (page 64)

- 5 DVD TOP MENU button**
Press to display the DVD title on the TV screen.

DVD/TUNER MENU button
(page 31, 32, 44)

RETURN button (page 31)

OPTIONS button
Press to enter or exit options menu.

↕/↔/↔/↔ button
Press to select the menu items.

+ button
Press to enter/confirm the settings.

- 6  MUSIC SERVICE button**
(page 52)
Press to start/resume the music service.

- 7  (volume) +/-*2 button**
Press to adjust the volume.

- 8 SHIFT*1 button**
Hold down to activate the buttons printed in pink.

- 9  (fast reverse/fast forward) button** (page 31)
Press to find a point in a track or file during playback.



 (slow back/slow forward) button (page 31)
Press to play in slow-motion.

TUNING+/- button (page 44)

 (play)*2 button
Press to start playback.

 (go backward/go forward) button (page 31)
Press to select a track or file.

PRESET+/- button (page 44)

 (pause) button
Press to pause playback. To resume playback, press .

 (stop) button
– Press to stop playback.
When pressed twice, resume playback can be canceled.
– Press to stop transfer during music transfer.
– Press to stop the built-in sound demonstration.

- 10 FUNCTION +/- button**
Press to select a function.

- 11 MEGA BASS button** (page 56)

- 12 SOUND FIELD button** (page 56)

MUSIC button (page 57)

MUSIC ARENA button (page 56)

- 13 PARTY LIGHT button** (page 29, 66)

LIGHT MODE button (page 66)



- 14 DISPLAY button** (page 23, 29, 36, 44, 46)
Press to change the information on the display.

 **DISPLAY*¹ button (page 36)**

Press to view or hide the on-screen display.

15 SLEEP button (page 66)

*¹ This button is printed in pink. To use this button, hold down SHIFT () button, then press this button.

*² The numeric button 2/AUDIO,  + and  buttons have a tactile dot. Use the tactile dot as a reference when operating the system.

Getting Started

Assembling the unit

Make sure that two people handle the unit when mounting it. Dropping the unit may cause personal injury and/or property damage.

Mount the satellite unit on the subwoofer unit, then secure firmly by tightening the supplied screws (M5 × 30).

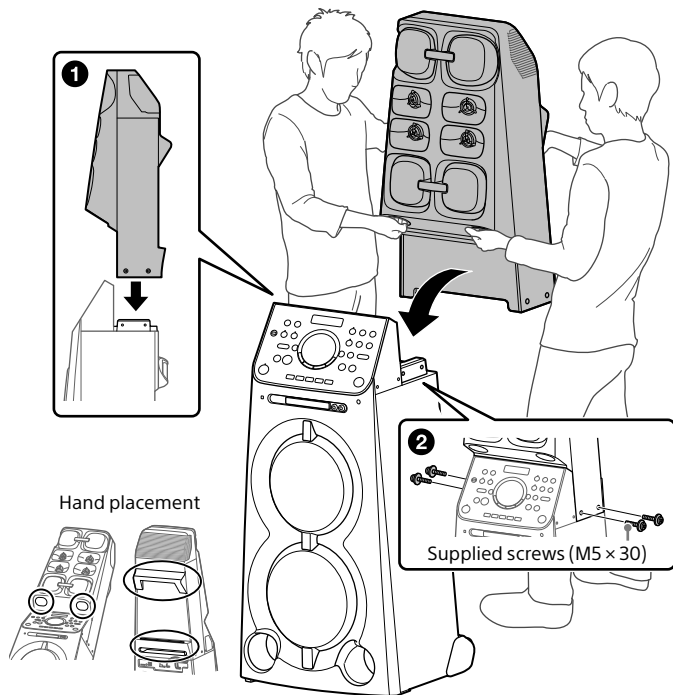

Note

- Be sure to use the supplied screws (M5 × 30) to assemble the unit.
- Be careful not to pinch your fingers or speaker cords while mounting the satellite unit.
- After assembling the unit, make sure the satellite unit is securely fixed to the subwoofer unit with the supplied screws.
- When using an electric screwdriver to tighten the screws, make the torque setting to approximately 1 N·m {10 kgf·cm}.
- Do not place the unit on unstable surfaces. Be sure to place the unit on flat surfaces.
- Be sure to retighten the screws when they become loose by using this unit.

Hooking up the system securely

Unit (Rear):

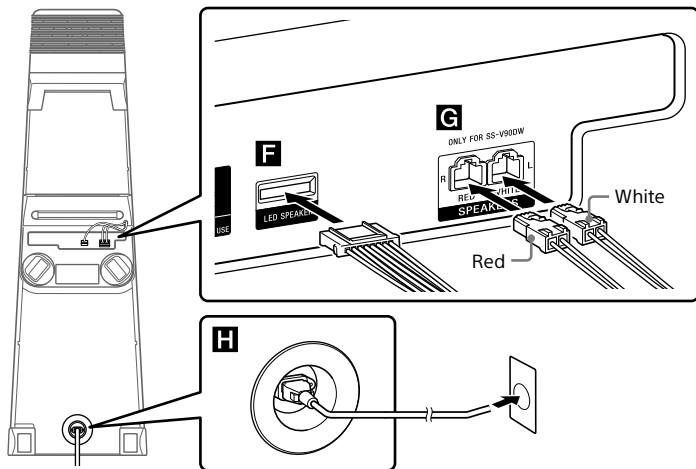

To store the speaker cords tidily

Route the cords through the cord stopper.

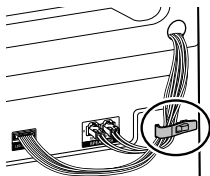

Connector panel:

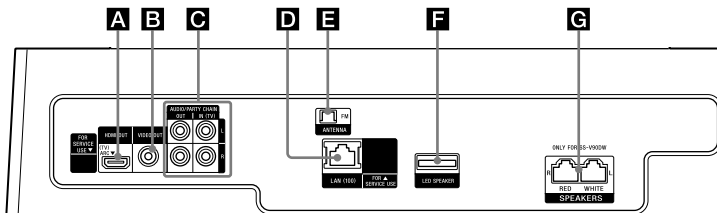

A HDMI OUT (TV) jack

Use an HDMI cable (not supplied) to connect to the HDMI IN jack of a TV (page 25).

B VIDEO OUT jack

Use a video cable (not supplied) to connect to the video input jack of a TV or projector (page 25).

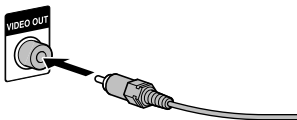

Note

Do not connect this system to the TV through the video deck.

C Audio input and output jacks

Use an audio cable (not supplied) to make either connection as follows:

• AUDIO/PARTY CHAIN OUT L/R jacks

- Connect to the audio input jacks of an optional equipment.
- Connect to another audio system to enjoy the Party Chain function (page 61).

• AUDIO/PARTY CHAIN IN (TV) L/R jacks

- Connect to the audio output jacks of a TV or an audio/video equipment. The sound is output through this system.
- Connect to another audio system to enjoy the Party Chain function (page 61).

D LAN (100) port

Use a LAN cable (not supplied) to connect to a network equipment (page 50).

E FM ANTENNA terminal

Find a location and an orientation that provide good reception when you set up the antennas.
Keep the antenna away from the AC power cord (mains lead) and the USB cable to avoid picking up noise.

Extend the FM lead antenna horizontally



F LED SPEAKER terminal

Connect the LED speaker connector of the speakers to this terminal. The lighting on the speakers will react according to the music source (page 66).

To disconnect the speaker cord

Pull out the connector from the terminal.

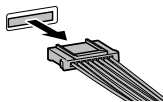

G SPEAKERS L/R terminals

Connect the speaker connector of the speaker unit to this terminal.

Note

- Be sure to use only the supplied speaker.
- When connecting speaker cord, insert the connector straight into the terminal.
- Make sure that the connector of the right speaker is properly connected to the SPEAKERS R terminal, and the connector of the left speaker is properly connected to the SPEAKERS L terminal.

To disconnect the speaker cord

While pushing down the lock lever, pull out the connector from the terminal. Do not pull the wire without pushing down the lock lever. Doing so may cause the wire to break.

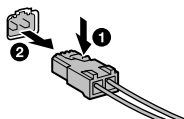
**H AC power cord (mains lead)**

Connect the AC power cord (mains lead) (supplied) to the unit, then to the wall outlet. When the AC power cord (mains lead) is connected, the system is performing initialization. During system initialization, "WELCOME" appears on the display. While the initializing is in progress, you cannot turn on the system. After initialization completes, demonstration (page 29) starts automatically. If you press  to turn on the system, the demonstration ends.

Deactivating the demonstration

To deactivate the demonstration while the system is turned off, press DISPLAY repeatedly to select the no display mode (Power Saving Mode) (page 29).

Inserting batteries

Insert the two supplied R03 (size AAA) batteries, matching the polarities shown below.

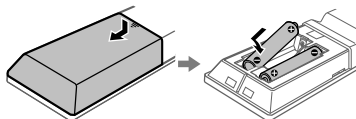
**Note**

- Do not mix an old battery with a new one or mix different types of batteries.
- If you do not use the remote control for a long period of time, remove the batteries to avoid damage from battery leakage and corrosion.

To operate the unit using the remote control

Point the remote control at the unit's remote control sensor.

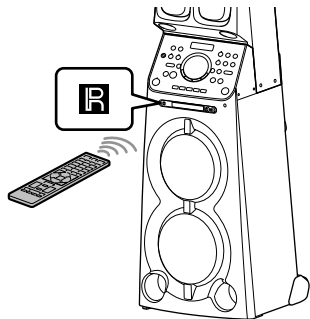

Connecting the TV

Before connecting cables, be sure to disconnect the AC power cord (mains lead).

To watch video

Select the connection methods according to the jacks on your TV.

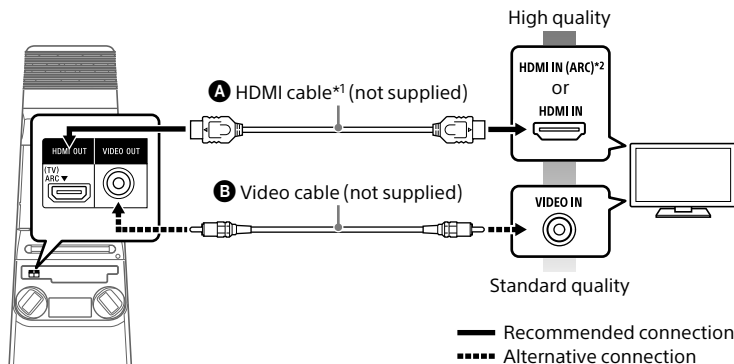

*¹ High Speed HDMI Cable with Ethernet

*² You can listen to TV sound via the system if you connect the system to the TV's HDMI IN (ARC) jack. The Audio Return Channel (ARC) function enables the TV to output sound through the system with an HDMI connection, without performing an audio connection (connection **C** below). To set the ARC function on this system, see [AUDIO RETURN CHANNEL] (page 40). To check the compatibility of your TV's ARC function, refer to the operating instructions supplied with your TV.

To listen to TV sound via the system

If you do not connect the system to the TV's HDMI IN (ARC) jack, make this connection.

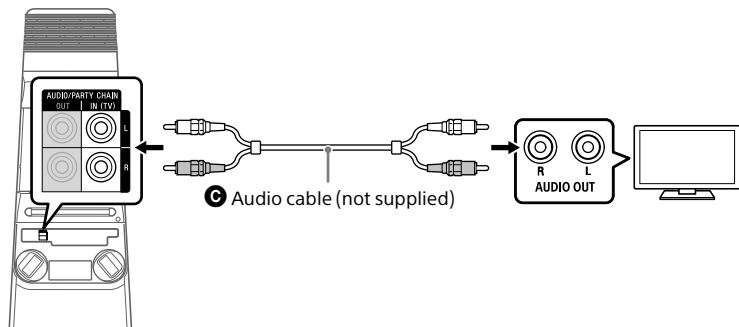

To listen to TV sound, press FUNCTION +/- repeatedly to select "TV".

Hint

- You can also enjoy the sound of external equipment (DVD players, etc.) via the system by connecting to the AUDIO/PARTY CHAIN IN (TV) jack as connection **C** above. For details, refer to the operating instructions of your equipment.
- If the audio output level from the system is low when connecting the external equipment, try adjusting the audio output settings on the connected equipment. It may improve the audio output level. For details, refer to the operating instructions of your equipment.

Carrying the unit

The unit has caster wheels so that you can roll it easily.
Before carrying the unit, disconnect the AC power cord (mains lead).

Carrying the unit by this method is recommended:

— on flat surfaces:

When carrying alone

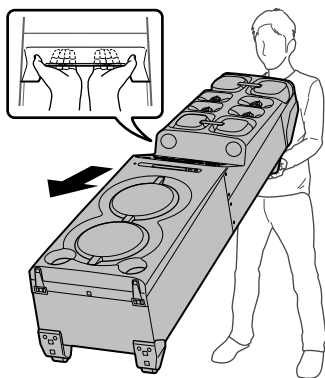

When carrying with two people

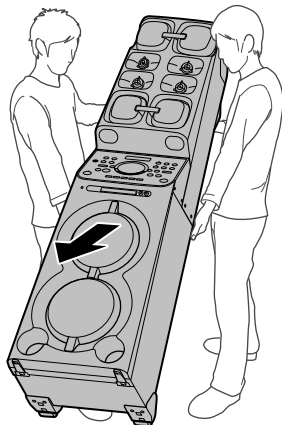

— on uneven surfaces:

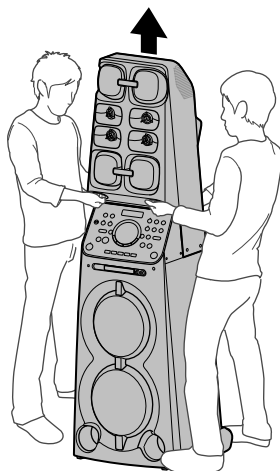

Note

- The caster wheels can be used only on flat surfaces. Lift the unit by two people on uneven surfaces. Correct hand placement while carrying the unit is very important to avoid personal injury and/or property damage. Be sure to use the handle when lifting the unit.

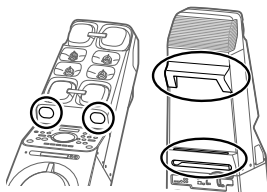

- Exercise extreme caution when carrying the unit on a slope.
- Do not carry the unit with a person, luggage, etc. on it.
- Do not let children or infants be near when carrying the unit.

For children

- Do not allow children to climb on the unit.
- If the unit falls down, it may cause head injuries, broken limbs, or other serious physical damage.
- Warning: Keep small accessories out of the reach of children, so that they are not mistakenly swallowed (e.g., AC plug adaptor, batteries, screws, etc.).



Changing the color system

(Except for Latin American, European, and Russian models)

Set the color system to PAL or NTSC depending on the color system of your TV.

Each time you perform the procedure below, the color system changes as follows:
NTSC ↔ PAL

Use the keys on the touch panel of the unit to perform this operation.

- 1** Press to turn on the system.
- 2** Touch **FUNCTION** repeatedly to select "DVD/CD".
- 3** Touch and hold **DJ** and **TUNING +** for more than 2 seconds. "NTSC" or "PAL" appears on the display.

Performing the quick setup

Before using the system, you can make the minimum basic adjustments in the quick setup.

- 1** Turn on your TV and select the input according to the connection.
- 2** Press to turn on the system.
- 3** Press **FUNCTION +/-** repeatedly to select "DVD/CD".

The guide message [Press ENTER to run QUICK SETUP.] appears at the bottom of the TV screen.

- 4** Press without loading a disc. [LANGUAGE SETUP] appears on the TV screen. Displayed items may vary depending on country or region.

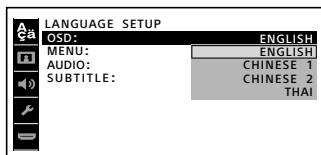

- 5** Press **+/-** repeatedly to select a language, then press . [VIDEO SETUP] appears on the TV screen.
- 6** Press **+/-** repeatedly to select the setting that matches your TV type, then press . After [QUICK SETUP is complete.] appears on the TV screen, the system is ready for playback.

To change the setting manually

See "Using the Setup Menu" (page 37).

To quit the quick setup

Press DVD SETUP.

Note

The guide message appears when you turn on the system for the first time or after performing [RESET] (see "Returning the setup menu settings to the default" on page 80).

Changing the display mode

Press DISPLAY repeatedly while the system is turned off.

Each time you press the button, the display mode changes as follows.

Demonstration

The messages about the main features of this system scrolls across the display and the illumination turns on.

To turn off the illumination, press PARTY LIGHT.

No display (Power Saving Mode)

The display is turned off to conserve power.

Disc/USB Playback

Before using the USB device

For compatible USB devices, see "Websites for compatible devices" (page 12).

Basic playback

DVD-V VIDEO CD C D DATA CD DATA DVD USB

- 1 Press **FUNCTION +/-** repeatedly to select "DVD/CD" or "USB".
Alternatively, touch **PLAYBACK**, then touch DVD/CD or USB on the unit.

- 2 Prepare the playback source.

For DVD/CD function:

Touch **▲** on the unit to open the disc tray and load a disc with the label facing up on the disc tray.

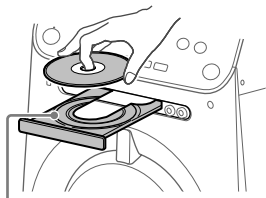

When you play back an 8 cm disc such as a CD single, place it on the inner circle of the tray.

Touch **▲** on the unit again to close the disc tray.

Do not forcibly push the disc tray to close it as this may cause a malfunction.

For USB function:

Connect a USB device to the **ψ** (USB) port.

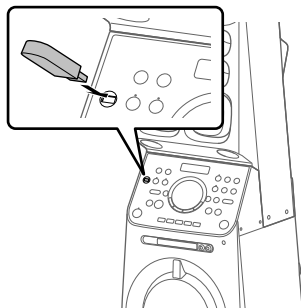

Note

You can use a USB adaptor (not supplied) to connect the USB device to the unit if the USB device cannot be plugged into the **ψ** (USB) port.

- 3 (**DATA CD DATA DVD USB** only)
Press **MEDIA MODE** repeatedly to select the media type ([MUSIC]/[VIDEO]) you want.
- 4 Press **▶** to start playback.

Other operations

To	Do this
Stop playback	Press ■ .
Pause playback	Press ⏸ .
Resume playback or return to normal playback	Press ▶ .
Cancel the resume point	Press ■ twice.
Select a track, file, chapter or scene	Press ◀◀ or ▶▶ during playback. Or, hold down SHIFT , press the numeric buttons, then press [+] .* (Operation might be prohibited by disc or USB device.)

* This operation is not available for audio file playback of USB device.

To use the Gesture Control during playback

See page 54.

To play from a specific video file on the disc or USB device

- 1 Press **MEDIA MODE** repeatedly to select **[VIDEO]**.
- 2 Hold down **SHIFT**, then press **SEARCH** to display the folder list.

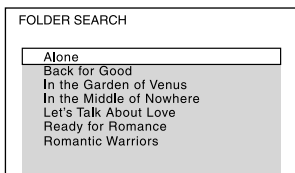

- 3 Press **↑/↓** repeatedly to select the folder you want.

- 4 Press **[+]** to display the file list.



- 5 Press **↑/↓** repeatedly to select the file you want, then press **[+]**.

Other playback operations

DVD-V **VIDEO CD** **CD** **DATA CD** **DATA DVD** **USB**

Depending on the type of disc or file, the function may not work.

To	Do this
View DVD menu	Press DVD/TUNER MENU .
View folder list or file list	Hold down SHIFT , then press SEARCH . Press SEARCH again to turn off the folder list or file list.
Return to folder list when in file list	Press RETURN .
Find a point in an audio file of USB device	Hold down ◀◀ or ▶▶ during playback.
Locate a point quickly in fast forward or fast reverse (Lock Search)	Press ◀◀ or ▶▶ during playback. Each time you press ◀◀ or ▶▶ , the playback speed changes.
Watch frame by frame (Slow-motion Play)	Press ⏸ , then press ◀◀ or ▶▶ . Each time you press ◀◀ or ▶▶ , the playback speed changes.

Searching a specific title/ chapter/scene/track/index

DVD-V VIDEO CD

- 1 Hold down SHIFT, then press SEARCH repeatedly during playback to select the search mode.
- 2 Hold down SHIFT, press the numeric buttons to enter the title, chapter, scene, track, or index number you want, then press . Playback starts.

Note

- For VIDEO CD with PBC playback, hold down SHIFT, then press SEARCH to search the scene.
- For VIDEO CD without PBC playback, hold down SHIFT, then press SEARCH to search the track and index.





To search for a particular point using the time code

DVD-V

- 1 Hold down SHIFT, then press SEARCH repeatedly during playback to select the time search mode.
- 2 Hold down SHIFT, press the numeric buttons to enter the time code, then press .
Example: To find a scene at 2 hours, 10 minutes, and 20 seconds after the beginning, hold down SHIFT, then press 2, 1, 0, 2, 0 ([2:10:20]).
If you make a mistake, press CLEAR to cancel the number.

To search using the DVD menu

DVD-V

- 1 Press DVD/TUNER MENU.
- 2 Press ///, or hold down SHIFT and press the numeric buttons, to select the title or item you want to play back, then press .

Changing the camera angles

DVD-V

Press ANGLE repeatedly during playback to select the camera angle you want.

Selecting the subtitle setting

DVD-V

Press SUBTITLE repeatedly during playback to select the subtitle language you want or turn off the subtitle.

Changing the language/sound

DVD-V VIDEO CD C D DATA CD DATA DVD

Press AUDIO repeatedly during playback to select the audio format or mode you want.

DVD VIDEO

You can select audio format or language when the source contains multiple audio formats or multilingual audio.

When 4 digits are displayed, they indicate a language code. See “Language code list” (page 90) to confirm which language the code represents. When the same language is displayed two or more times, the DVD VIDEO is recorded in multiple audio formats.

VIDEO CD/AUDIO CD/DATA CD/ DATA DVD (MP3 file)

You can change the sound output.

- [STEREO]: The standard stereo sound.
- [1/L]/[2/R]: The monaural sound of the left or right channel.

SUPER VIDEO CD

- [1:STEREO]: The stereo sound of audio track 1.
- [1:1/L]/[1:2/R]: The monaural sound of the left or right channel of audio track 1.
- [2:STEREO]: The stereo sound of audio track 2.
- [2:1/L]/[2:2/R]: The monaural sound of the left or right channel of audio track 2.

Playing a VIDEO CD with PBC functions

VIDEO CD

You can use the PBC (Playback Control) menu to enjoy the interactive features of VIDEO CD (VIDEO CD Version 2.0 and Super VCD).

1 Press ► to play a VIDEO CD with PBC functions.

The PBC menu appears on the TV screen.

2 Hold down SHIFT, press the numeric buttons to select the item number you want, then press [+].

3 Continue playback according to the instructions on the menu.

Note

PBC playback is canceled when Repeat Play is activated.

To cancel PBC playback

1 Press ◀◀ or ▶▶, or hold down SHIFT and press the numeric buttons, to select a track when playback is stopped.

2 Press ► or [+].

Playback starts from the selected track.

To return to PBC playback

Press ■ twice, then press ►.

Multi-disc resume play

DVD-V VIDEO CD

This system can store playback resume points for up to 6 discs and resumes playback when you insert the same disc again. If you store a playback resume point for the 7th disc, the resume point for the first disc will be deleted.

To activate this function, set [MULTI-DISC RESUME] in [SYSTEM SETUP] to [ON] (page 39).

Note

To play back from the beginning of the disc, press ■ twice, then press ►.

Using play mode

Playing in sequential order (Normal Play)

CD DATA CD DATA DVD USB

When playback is stopped, press **PLAY MODE** repeatedly.

■ When playing a disc

- [DISC]: plays the disc.
- [FOLDER]*: plays all playable files in the specified folder on the disc.

* Cannot be selected for AUDIO CD.

■ When playing a USB device

- [ONE USB DEVICE]: plays the USB device.
- [FOLDER]: plays all playable files in the specified folder on the USB device.

Note

- "FLDR" and "SHUF" light off on the display when Normal Play is set to [DISC] or [ONE USB DEVICE].
- "FLDR" lights up on the display when Normal Play is set to [FOLDER].
- When USB function and [MUSIC] mode are selected, select the play mode you want by viewing the indicators on the display.

Playing in random order (Shuffle Play)

CD DATA CD DATA DVD USB

When playback is stopped, press **PLAY MODE** repeatedly.

■ When playing a disc

- [DISC (SHUFFLE)]: shuffles all audio files on the disc.

- [FOLDER (SHUFFLE)]*: shuffles all audio files in the specified folder on the disc.

* Cannot be selected for AUDIO CD.

■ When playing a USB device

- [ONE USB DEVICE (SHUFFLE)]: shuffles all audio files on the USB device.
- [FOLDER (SHUFFLE)]: shuffles all audio files in the specified folder on the USB device.

Note

- "SHUF" lights up on the display when Shuffle Play is set to [DISC (SHUFFLE)] or [ONE USB DEVICE (SHUFFLE)].
- "FLDR" and "SHUF" lights up on the display when Shuffle Play is set to [FOLDER (SHUFFLE)].
- When USB function and [MUSIC] mode are selected, select the play mode you want by viewing the indicators on the display.
- Shuffle Play cannot be performed for video files.
- Shuffle Play is canceled when you:
 - open the disc tray.
 - perform Synchronized Transfer.
 - change MEDIA MODE.
- Shuffle Play may be canceled when you select a folder or a track to play back.

Playing repeatedly (Repeat Play)

DVD-V VIDEO CD CD DATA CD DATA DVD USB

Press **REPEAT** repeatedly.

Depending on the type of disc or file, some settings may not be available.

- [OFF]: does not play back repeatedly.
- [ALL]: repeats all tracks or files in the selected play mode.
- [DISC]: repeats all contents (DVD VIDEO and VIDEO CD only).

- [TITLE]: repeats the current title (DVD VIDEO only).
- [CHAPTER]: repeats the current chapter (DVD VIDEO only).
- [TRACK]: repeats the current track.
- [FILE]: repeats the current video file.

To cancel Repeat Play

Press REPEAT repeatedly to select [OFF].

Note

- "⏮" lights up on the display when Repeat Play is set to [ALL] or [DISC].
- "⏮ 1" lights up on the display when Repeat Play is set to [TITLE], [CHAPTER], [TRACK] or [FILE].
- When USB function and [MUSIC] mode are selected, select the play mode you want by viewing the indicators on the display.
- You cannot perform Repeat Play with VIDEO CD during PBC playback.
- Depending on the DVD VIDEO, you cannot perform Repeat Play.
- Repeat Play is canceled when you
 - open the disc tray.
 - turn off the system (DVD VIDEO and VIDEO CD only).
 - change the function (DVD VIDEO and VIDEO CD only).
 - perform Synchronized Transfer.
 - change MEDIA MODE.

Restricting playback of the disc (Parental Control)

DVD-V

You can restrict playback of DVD VIDEOS according to a predetermined level. Scenes may be skipped or replaced with different scenes.

- 1 When playback is stopped, press DVD SETUP.
- 2 Press \uparrow/\downarrow repeatedly to select [SYSTEM SETUP], then press $\boxed{+}$.
- 3 Press \uparrow/\downarrow repeatedly to select [PARENTAL CONTROL], then press $\boxed{+}$.
- 4 Hold down SHIFT, press the numeric buttons to enter or re-enter your 4-digit password, then press $\boxed{+}$.
- 5 Press \uparrow/\downarrow repeatedly to select [STANDARD], then press $\boxed{+}$.
- 6 Press \uparrow/\downarrow repeatedly to select a geographic area as the playback limitation level, then press $\boxed{+}$.
The area is selected.
When you select [OTHERS→], enter the area code for the geographic area you want according to the "Parental Control area code list" (page 91) by holding down SHIFT, then press the numeric buttons.
- 7 Press \uparrow/\downarrow repeatedly to select [LEVEL], then press $\boxed{+}$.
- 8 Press \uparrow/\downarrow repeatedly to select the level you want, then press $\boxed{+}$.
The lower the value, the stricter the limitation.

To turn off the parental control function

Set [LEVEL] to [OFF] in step 8.

To play back a disc for which the parental control is set

- 1 Load the disc and press ►.
The display for entering your password appears on the TV screen.

- 2 Hold down SHIFT, press the numeric buttons to enter or re-enter your 4-digit password, then press **[+]**.

The system starts playback.

If you forget your password

Remove the disc and repeat steps 1 to 3 of "Restricting playback of the disc (Parental Control)" (page 35). Hold down SHIFT, press the numeric buttons to enter a password "199703", then press **[+]**.

Follow the on-screen instructions and enter a new 4-digit password. Then, reload the disc and press **[▶]**.

You need to enter your new password again.

Viewing information of a disc and USB device

DVD-V VIDEO CD C D DATA CD DATA DVD USB

Information on the TV screen

Hold down SHIFT, then press **[DISPLAY]** repeatedly during playback.

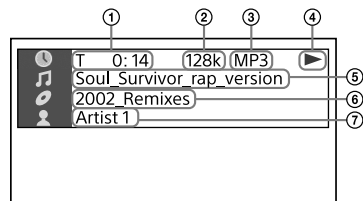

- 1 **Playback information**
Playing time and remaining time
- 2 **Bit rate**
- 3 **File type**
- 4 **Playback status**

- 5 **Title^{*1}/track/file name^{*2}**

- 6 **Album^{*1}/folder name^{*2}/chapter/index number**

- 7 **Artist name^{*1*2}**

Appears when playing an audio file.

^{*1} If an audio file has an ID3 tag, the system will display an album name/ title name/artist name from the ID3 tag information. The system can support ID3 ver 1.0/1.1/2.2/2.3.

^{*2} If the file or folder contains characters which cannot be displayed, those characters will be displayed as "_".

Note

- Depending on the source being played,
 - some information may not be displayed.
 - some characters cannot be displayed.
- Depending on the play mode, the information displayed may be different.
- When USB function is selected, you can view the information on the TV screen only if MEDIA MODE is set to [VIDEO].

Displaying the audio format information in DVD VIDEOS and video files

Press **AUDIO** repeatedly during playback.

Information on the display

Press **DISPLAY** repeatedly when the system is on.

You can view the information as follows:

- playing time, remaining time of track, title, chapter
- scene number
- file name, folder name
- title, artist and album information

Note

- The disc name or track name may not be displayed depending on the characters.
- Playing time of audio files and video files may not be displayed correctly.
- The elapsed playing time for an audio file encoded using a VBR (variable bit rate) is not displayed correctly.

Using the Setup Menu

You can make various adjustments to items such as picture and sound. Displayed items vary depending on the country or region.

Note

Playback settings stored in the disc take priority over the setup menu settings. Therefore, some of the setup menu settings may not be performed.

1 When playback is stopped in DVD/CD function, press DVD SETUP.

The setup menu appears on the TV screen.

2 Press \uparrow/\downarrow repeatedly to select [LANGUAGE SETUP], [VIDEO SETUP], [AUDIO SETUP], [SYSTEM SETUP] or [HDMI SETUP], then press $\boxed{+}$.

3 Press \uparrow/\downarrow repeatedly to select the item you want, then press $\boxed{+}$.

4 Press \uparrow/\downarrow repeatedly to select the setting you want, then press $\boxed{+}$.

The setting is selected and setup is completed.

To exit the menu

Press DVD SETUP.



Setting the language

- [LANGUAGE SETUP]

[OSD]

Sets the language of the on-screen display.

[MENU]**DVD-V**

Sets the language for the DVD menu.

[AUDIO]**DVD-V**

Switches the language of the sound track.

When you select [ORIGINAL], the language given priority in the disc is selected.

[SUBTITLE]**DVD-V**

Switches the language of the subtitle recorded in the DVD VIDEO. When you select [AUDIO FOLLOW], the language for the subtitles changes according to the language you selected for the sound track.

Note

If you select [OTHERS \rightarrow] in [MENU], [AUDIO], and [SUBTITLE], enter a language code from the "Language code list" (page 90) using the numeric buttons.



Setting the TV screen - [VIDEO SETUP]

[TV TYPE]

DVD-V

[16:9]: Selects this when you connect a wide-screen TV or a TV with a wide-mode function.



[4:3 LETTER BOX]: Selects this when you connect a 4:3 screen TV that does not have a wide-mode function. This setting displays a wide picture with black bands on the top and bottom.



[4:3 PAN SCAN]: Selects this when you connect a 4:3 screen TV that does not have a wide-mode function. This setting displays a full-height picture on the entire screen, with trimmed sides.



[4:3 OUTPUT]

DVD-V

[FULL]: Selects this when you connect a TV with a wide-mode function. Displays a 4:3 screen picture in 16:9 aspect ratio even on a wide-screen TV.

[NORMAL]: Changes the picture size to fit the screen size with the original picture aspect ratio. This setting displays black bands on the left and right side if you display a 4:3 screen picture.



[COLOR SYSTEM(VIDEO CD)]

(Except for Latin American, European, and Russian models)

VIDEO CD

Sets the color system (PAL or NTSC).

[AUTO]: Outputs the video signal according to the color system of the disc. Select this setting if your TV uses a DUAL system.

[PAL]: Changes the video signal of an NTSC disc and output it in PAL system.

[NTSC]: Changes the video signal of a PAL disc and output it in NTSC system.

For details, see "Changing the color system" (page 28).

[BLACK LEVEL]

(Latin American model only)

Selects the black level (setup level) for the video signals output from the VIDEO OUT jack.

[ON]: Sets the black level of the output signal to the standard level.

[OFF]: Lowers the standard black level. Use this when the picture becomes too white.

[PAUSE MODE]

DVD-V

[AUTO]: The picture, including subjects that move dynamically, is output with no jitter. Normally select this setting.

[FRAME]: The picture, including subjects that do not move dynamically, is output in high resolution.



Setting the audio options – [AUDIO SETUP]

[TRACK SELECTION]

DVD-V

Gives priority to the sound track which contains the highest number of channels when you play back a DVD VIDEO on which multiple audio formats (PCM, MPEG audio, or Dolby Digital) are recorded.

[OFF]: No priority given.

[AUTO]: Priority given.

[A/V SYNC]

DVD-V VIDEO CD DATA CD DATA DVD

(Video files only)

[OFF]: Does not adjust.

[ON]: Adjusts the delay between picture and sound when the sound does not synchronize with the displayed picture.

Note

- Depending on the playback contents, this function may not work.
- When you use HDMI connection, this function is only effective if you set [HDMI SETUP] – [AUDIO(HDMI)] to [PCM].

[DOWNMIX]

DVD-V

Selects the audio output signal for playing a multi-channel audio.

[NORMAL]: Outputs multi-channel audio into a 2-channel stereo signal.

[DOLBY SURROUND]: Outputs multi-channel audio into a 2-channel surround signal.

Note

This function only works for the HDMI OUT (TV) jack. To use this function, be sure to set [HDMI SETUP] – [AUDIO(HDMI)] to [PCM].



Setting the system – [SYSTEM SETUP]

[SCREEN SAVER]

The screen saver will help prevent your display device from becoming damaged (ghosting). Press \triangle +/- to exit the screen saver.

[ON]: The screen saver image appears if you do not operate the system for about 15 minutes.

[OFF]: Turns off the function. The screen saver image does not appear.

[BACKGROUND]

Selects the background color or picture to be displayed on the TV screen.

[JACKET PICTURE]: The jacket picture (still picture) recorded on the disc appears in the background.

[GRAPHICS]: A preset picture stored in the system appears in the background.

[BLUE]: The background color is blue.

[BLACK]: The background color is black.

[PARENTAL CONTROL]

Sets the playback restrictions. For details, see “Restricting playback of the disc (Parental Control)” (page 35).

[MULTI-DISC RESUME]

DVD-V VIDEO CD

[ON]: Stores the resume playback point in the memory for up to 6 discs.

[OFF]: Playback starts at the resume playback point only for the current disc in the system.

[RESET]

Returns the setup menu settings to the default settings. For details, see "Returning the setup menu settings to the default" (page 80).



Setting the HDMI options – [HDMI SETUP]

[HDMI RESOLUTION]

Selects the TV output resolution when the TV is connected via HDMI cable.

[AUTO(1920×1080p)]: Outputs video signals according to the resolution of the TV.

[1920×1080i]/[1280×720p]/

[720×480p]^{*1}/[720×480/576p]^{*2}:

Outputs video signals according to the selected resolution setting.

^{*1} For Latin American models only.

^{*2} For other models.

[YCbCr/RGB(HDMI)]

[YCbCr]: Outputs YCbCr video signals.

[RGB]: Outputs RGB video signals.

[AUDIO(HDMI)]

[AUTO]: Outputs audio signals in original format from HDMI OUT (TV) jack.

[PCM]: Outputs 2-channel Linear PCM signals from HDMI OUT (TV) jack.

[CONTROL FOR HDMI]

[ON]: The Control for HDMI function is enabled. You can operate mutually between system and TV connected with an HDMI cable.

[OFF]: Off.

[AUDIO RETURN CHANNEL]

Set this function when the system is connected to a TV's HDMI IN jack that is compatible with Audio Return Channel. This function is available when you set [CONTROL FOR HDMI] to [ON].

[ON]: You can listen to TV sound from the speakers of the system.

[OFF]: Off.

[STANDBY LINKED TO TV]

This function is available when you set [CONTROL FOR HDMI] to [ON].

[AUTO]: When you turn off the TV, the system turns off automatically in the following conditions:

- a VIDEO CD or DVD VIDEO is loaded in DVD/CD function
- a DATA CD or DATA DVD is loaded and [VIDEO] mode is selected
- USB function and [VIDEO] mode are selected
- TV function is selected

[ON]: The system turns off automatically when you turn off the TV regardless of the function.

[OFF]: The system does not turn off when you turn off the TV.

USB Transfer

Before using the USB device

For compatible USB devices, see “Websites for compatible devices” (page 12).

(You can use your Apple devices with this system via BLUETOOTH connection only.)

Transferring music

You can transfer music from a disc (AUDIO CD or MP3 disc only) to a USB device connected to the Ψ (USB) port.

The audio format of files transferred by this system is MP3.

Note

- Do not remove the USB device during transfer or erase operations. Doing so may corrupt the data on the USB device or damage the USB device itself.
- MP3 files are transferred with the same bit rate as the original files.
- When transferring from AUDIO CD, you may select the bit rate before transferring.
- USB transfer and erase operations are prohibited when the disc tray is opened.

Note on copyright-protected content

The transferred music is limited to private use only. Use of the music beyond this limit requires permission of the copyright holders.

To select the bit rate

You can select a higher bit rate to transfer music with better quality.

- 1 Press **OPTIONS**.

- 2 Press \uparrow/\downarrow repeatedly to select “**BIT RATE**”, then press \square .

- 3 Press \uparrow/\downarrow repeatedly to select the bit rate you want, then press \square .

- “128 KBPS”: encoded MP3 files have smaller file size and lower audio quality.
- “256 KBPS”: encoded MP3 files have bigger file size but higher audio quality.

To exit the options menu, press **OPTIONS**.

Transferring music from a disc

You can transfer music to a USB device connected to Ψ (USB) port as follows:

- Synchronized Transfer: Transfer all MP3 files from a disc to USB.
- REC1 Transfer: Transfer a single track or MP3 file during playback.

- 1 **Connect a transferable USB device to the Ψ (USB) port.**

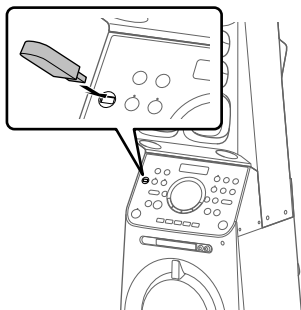

Note

You can use a USB adaptor (not supplied) to connect the USB device to the unit if the USB device cannot be plugged into the Ψ (USB) port.

2 Press FUNCTION +/- repeatedly to select "DVD/CD", then load a disc.

3 Prepare the sound source.

Synchronized Transfer:

If the system starts playback automatically, press ■ twice to stop the playback fully.

When playback is stopped, press PLAY MODE repeatedly to select the play mode you want.

Note

If you start transferring in Shuffle Play or Repeat Play, the selected play mode changes to Normal Play automatically.

REC1 Transfer:

Select the track or MP3 file you want to transfer, then start playback.

4 Press REC TO USB.

"PUSH ENTER" appears on the display.

5 Press [+].

The transfer starts, then "DO NOT REMOVE" appears on the display. Do not remove the USB device until the transfer is complete.

When the transfer is complete, the system performs as follows:

Synchronized Transfer:

When the transfer is complete, the disc stops automatically.

REC1 Transfer:

The transfer is completed automatically, but the disc continues to play the next track or file.

To stop transfer

Press ■.

Notes on transfer

- You cannot transfer MP3 files on a UDF (Universal Disk Format) formatted disc to the USB device.
- While transferring, no sound is output.
- CD-TEXT information is not transferred to the created MP3 files.
- The transfer stops automatically if:
 - the USB device runs out of space during transfer.
 - the number of audio files or folders on the USB device reaches the limit that the system can recognize.
- If a folder or file that you are trying to transfer already exists on the USB device with the same name, a sequential number is added after the name without overwriting the original folder or file.
- You cannot perform the following operations during transfer:
 - Eject the disc.
 - Select another track or file.
 - Pause playback or find a point in the track or file.
 - Change the function.
- When transferring music to a WALKMAN® using "Media Manager for WALKMAN", be sure to transfer in MP3 format.
- When connecting a WALKMAN® to the system, be sure to connect after the display "Creating Library" or "Creating Database" on the WALKMAN® has disappeared.

Folder and file generation rules

Maximum number of MP3 files that can be generated

- 298 folders
- 650 files in a folder
- 650 files in REC1-CD or REC1-MP3 folder.

These numbers may vary depending on the file or folder configuration.

When transferring to a USB device, a "MUSIC" folder is created directly below "ROOT". Folders and files are generated within this "MUSIC" folder according to the transfer method and source as follows:

Synchronized Transfer

■ When transferring CD-DA tracks from an AUDIO CD

Folder name: "CDDA0001"*

File name: "TRACK001"*

■ When transferring MP3 files from a disc

Folder name: Same as the source

File name: Same as the source

REC1 Transfer

■ When transferring a CD-DA track from an AUDIO CD

Folder name: "REC1-CD"

File name: "TRACK001"*

■ When transferring an MP3 file from a disc

Folder name: "REC1-MP3"

File name: Same as the source

* Folder and file numbers are assigned serially thereafter.

Erasing audio files or folders on the USB device

1 Press FUNCTION +/- repeatedly to select "USB".

Alternatively, touch PLAYBACK, then touch USB on the unit.

2 Press MEDIA MODE repeatedly to select [MUSIC].

3 When playback is stopped, press OPTIONS.

4 Press \uparrow/\downarrow repeatedly to select "ERASE", then press $\boxed{+}$.

The folder list is displayed on the TV screen.

5 Press \uparrow/\downarrow repeatedly to select a folder, then press $\boxed{+}$.

The file list is displayed on the TV screen.

6 Press \uparrow/\downarrow repeatedly to select an audio file you want to erase, then press $\boxed{+}$.

If you want to erase all the audio files in the folder, select [ALL TRACKS] on the list.

"FOLDER ERASE" or "TRACK ERASE" and "PUSH ENTER" appear on the display.

To cancel erase operations, press ■.

7 Press $\boxed{+}$.

"COMPLETE" appears on the display.

To exit the options menu, press ■.

Note

- You can erase MP3/WMA/AAC/WAV format file only.
- A folder that contains non-MP3/WMA/AAC/WAV format audio files or sub folders cannot be erased.
- Erase operation is prohibited when the disc tray is opened.

Tuner

Listening to the radio

- 1 Press FUNCTION +/- repeatedly to select "TUNER FM".**
Alternatively, touch PLAYBACK, then touch FM on the unit.

- 2 Tune to a station.**

For automatic scanning:

Hold down TUNING+/- until the frequency begins to change on the display.

Scanning stops automatically when a station is tuned in. "ST" (for FM stereo programs only) lights up on the display.

If scanning does not stop, press ■ to stop scanning. Then, perform manual tuning (below).

For manual tuning:

Press TUNING+/- repeatedly to tune to the station you want.

Note

When you tune to an FM station that provides RDS services, information such as the service name or station name is provided by broadcasts. You can check the RDS information by pressing DISPLAY repeatedly.

Hint

To reduce static noise on a weak FM stereo station, press FM MODE repeatedly until "ST" disappears from the display. You will lose the stereo effect, but reception will improve.

Presetting radio stations

You can store up to 20 FM stations as your favorite stations.

- 1 Tune to the station you want.**
- 2 Press DVD/TUNER MENU.**
- 3 Press +/- repeatedly to select the preset number you want, then press [+].**

"COMPLETE" appears on the display and the station is stored.

If another station is already assigned to the selected preset number, that station is replaced by the new one.

To listen to the preset station

Press PRESET+/- repeatedly to select the preset number you want.

BLUETOOTH

About the BLUETOOTH wireless technology

BLUETOOTH wireless technology is a short-range wireless technology that enables wireless data communication between digital devices.

Supported BLUETOOTH version, profiles and codecs

For details, see “BLUETOOTH section” (page 87).

Compatible BLUETOOTH devices

For details, see “Websites for compatible devices” (page 12).

About the BLUETOOTH indicator

The BLUETOOTH indicator on the unit lights up or flashes in blue to show the BLUETOOTH status.

System status	Indicator status
BLUETOOTH standby	Flashes slowly
BLUETOOTH pairing	Flashes quickly
BLUETOOTH connection is established	Lights up

Pairing this system with a BLUETOOTH device

Pairing is an operation where BLUETOOTH devices register with each other beforehand. Once a pairing operation is performed, it does not need to be performed again.

If your device is an NFC-compatible smartphone, the manual pairing procedure is not necessary. (See “One Touch BLUETOOTH Connection by NFC” (page 47).)

- 1 Place the BLUETOOTH device within 1 meter from the unit.**
- 2 Touch BLUETOOTH on the unit to select the BLUETOOTH function.** “BT AUDIO” appears on the display.

Hint

- When there is no pairing information on the system (for example, when you use the BLUETOOTH function for the first time after purchase), “PAIRING” flashes on the display and the system enters the pairing mode. Proceed to step 4.
- If the system is connected to a BLUETOOTH device, touch BLUETOOTH on the unit to disconnect the BLUETOOTH device.

- 3 Touch and hold – PAIRING on the unit for 2 seconds or more.** “PAIRING” flashes on the display.
- 4 Perform the pairing procedure on the BLUETOOTH device.**
For details, refer to the operating instructions of your BLUETOOTH device.

5 Select "MHC-V90DW" on the display of the BLUETOOTH device.

Perform this step within 5 minutes, otherwise pairing will be canceled. In this case, repeat from step 3.

Note

If passkey is required on the BLUETOOTH device, enter "0000". "Passkey" may be called "Passcode", "PIN code", "PIN number", or "Password".

6 Establish connection with the BLUETOOTH device.

When pairing is completed and the BLUETOOTH connection is established, BLUETOOTH device name appears on the display. Depending on the BLUETOOTH device, connection may start automatically after pairing is completed.

You can check the BLUETOOTH device address by pressing DISPLAY repeatedly.

Note

- You can pair up to 9 BLUETOOTH devices. If the 10th BLUETOOTH device is paired, the oldest paired device will be deleted.
- If you want to pair with another BLUETOOTH device, repeat steps 1 to 6.

To cancel the pairing operation

Touch and hold **PAIRING** on the unit for 2 seconds or more until "BT AUDIO" appears on the display.

Listening to music on a BLUETOOTH device

You can operate a BLUETOOTH device by connecting the system and the BLUETOOTH device using AVRCP.

Check the following before playing music:

- The BLUETOOTH function of the BLUETOOTH device is turned on.
- Pairing has been completed (page 45).

Once the system and the BLUETOOTH device are connected, you can control playback by pressing **▶**, **||**, **■**, **◀◀/▶▶** and **◀◀/▶▶**.

1 Touch BLUETOOTH on the unit to select the BLUETOOTH function.

"BT AUDIO" appears on the display.

2 Perform a BLUETOOTH connection with the BLUETOOTH device.

Touch BLUETOOTH on the unit to connect to the last connected BLUETOOTH device.

Perform the BLUETOOTH connection from the BLUETOOTH device if the device is not connected.

Once the connection is established, the BLUETOOTH device name appears on the display.

3 Touch **▶** to start playback.

Depending on the BLUETOOTH device,

- you may need to touch **▶** twice.
- you may need to start playing an audio source on the BLUETOOTH device.

4 Adjust the volume.

Adjust the volume of the BLUETOOTH device first. If the volume level is still too low, adjust the volume level on the system.

Note

- When the system is not connected to any BLUETOOTH device, the system will connect to the last connected BLUETOOTH device automatically when you touch BLUETOOTH on the unit or ►.
- If you try to connect another BLUETOOTH device to the system, the current connected BLUETOOTH device will be disconnected.

To use the Gesture Control during playback

See page 54.

To terminate the BLUETOOTH connection

Touch BLUETOOTH on the unit. "BT AUDIO" appears on the display. Depending on the BLUETOOTH device, the BLUETOOTH connection may be terminated automatically when you stop playback.

One Touch BLUETOOTH Connection by NFC

NFC (Near Field Communication) is a technology enabling short-range wireless communication between various devices, such as smartphones and IC tags. When you touch the system with an NFC-compatible smartphone, the system automatically:

- turns on in the BLUETOOTH function.
- completes the pairing and BLUETOOTH connection.

Compatible smartphones

NFC-compatible smartphones with Android™ 4.1 or later installed

Note

- The system can only recognize and connect to one NFC-compatible smartphone at a time. If you try to connect another NFC-compatible smartphone to the system, the currently connected NFC-compatible smartphone will be disconnected.
- Depending on your NFC-compatible smartphone, you may need to perform the following steps on your NFC-compatible smartphone in advance.
 - Turn on the NFC function. For details, refer to the operating instructions of the NFC-compatible smartphone.

1 Touch the smartphone to the N-Mark on the unit until the smartphone vibrates.

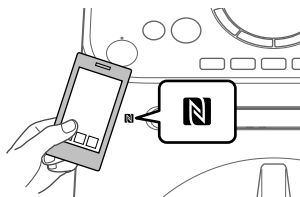

Complete the connection by following the instructions displayed on the smartphone.

When the BLUETOOTH connection is established, the BLUETOOTH device name appears on the display.

2 Start playback of an audio source on the smartphone.

For details, refer to the operating instructions of your BLUETOOTH device.

Hint

If pairing and the BLUETOOTH connection fail, do the following.

- Remove the case from the smartphone if using a commercially available smartphone case.
- Touch the smartphone to the N-Mark on the unit again.

To terminate the BLUETOOTH connection

Touch the smartphone to the N-Mark on the unit again.

Setting the BLUETOOTH audio codecs

You can enable AAC, LDAC or SBC codec from BLUETOOTH device. AAC/LDAC can be selected only when the BLUETOOTH device supports AAC/LDAC.

1 Press **OPTIONS**.

2 Press **↑/↓** repeatedly to select **"BT CODEC"**, then press **+**.

3 Press **↑/↓** repeatedly to select the setting, then press **+**.

- "AUTO": Enable reception in AAC or LDAC codec format depending on the BLUETOOTH device's capabilities.
- "SBC": Receive in SBC codec format.

To exit the options menu, press **OPTIONS**.

Note

- You can enjoy high quality sound if AAC or LDAC is selected. If you cannot listen to AAC or LDAC sound from your device or the sound is interrupted, select "SBC".
- If you change this setting while the system is connected to a BLUETOOTH device, the BLUETOOTH device will be disconnected. To connect to the BLUETOOTH device, perform the BLUETOOTH connection again.

Hint

LDAC is an audio coding technology developed by Sony that enables the transmission of High-Resolution (Hi-Res) Audio content, even over a BLUETOOTH connection. Unlike other BLUETOOTH compatible coding technologies such as SBC, it operates without any down-conversion of the Hi-Res Audio content*1, and allows approximately three times more data*2 than those other technologies to be transmitted over a BLUETOOTH wireless network with unprecedented sound quality, by means of efficient coding and optimized packetization.

*1 Excluding DSD format contents.

*2 In comparison with SBC (Subband Coding) when the bitrate of 990 kbps (96/48 kHz) or 909 kbps (88.2/44.1 kHz) is selected.

Selecting the method of network connection

If you connect this system to a network, you can enjoy this system in various ways. Depending on your network environment, setting up methods are different. Select the appropriate connecting method for your network environment from below.

Note

- Connecting to a Wi-Fi network and a wired network simultaneously is not possible. When you connect to a Wi-Fi network, be sure to disconnect the LAN cable from the unit.
- Depending on the function, the system may need to be updated.

Hint

For setting the fixed IP address, use the screen in step 6 of “Connecting with a computer” (page 49).

Method for using a smartphone/iPhone

Installing the “SongPal” application to your smartphone/iPhone is required.

Before making the connection, be sure to turn on the BLUETOOTH feature on your smartphone/iPhone, then operate the “SongPal” application to connect your smartphone or iPhone to this system via BLUETOOTH.

For details, refer to the Wi-Fi Startup Guide (separate document).

Method for using a wireless router with a WPS (AOSS) button

Touch and hold **WPS** on the unit, then press the Wi-Fi Protected Setup™ (WPS) button of the wireless router. For details, refer to the Wi-Fi Startup Guide (separate document).

Method for using computer

See “Connecting with a computer” (page 49).

Method for using wired network

Refer to Help Guide for details.
http://rd1.sony.net/help/has/mhc-v90dw/h_zz/



Connecting with a computer

If your wireless router does not have a WPS (AOSS) button, configure Wi-Fi settings by connecting the unit to your computer with a LAN cable (not supplied).

Hint

When setting up a Wi-Fi network, the SSID (Wi-Fi Network Name) and security key (WEP or WPA key) may be required. The security key (or network key) uses encryption to limit the devices with which communication can occur. It is used to provide higher security for devices communicating via a wireless router/access point.

1 Record the SSID and password of your router.

For details, refer to the operating instructions of your router.

SSID (Wi-Fi Network Name):

Password (Security Key):

2 Connect the unit to the computer with a LAN cable (not supplied) directly.

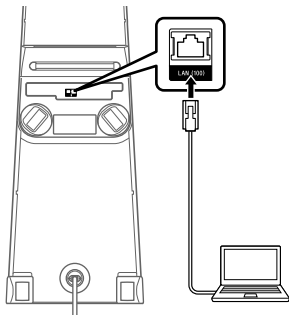

3 Press to turn on the system.

Wait until  lights up on the display. It takes about 2 minutes (in some cases, 4 or 5 minutes).

4 Access the [Sony Network Device Settings] screen.

Start the browser and input the following URL into the browser's address bar.

<http://169.254.1.1>

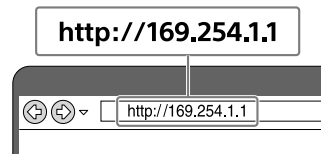

The above URL is only for when the PC and unit are connected with a LAN cable.

5 Select [Network Settings] from the menu.

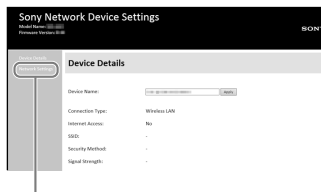

Network Settings

6 Select the SSID of your wireless router and enter the password.

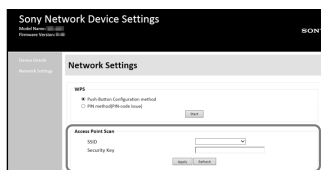



SSID

See the recorded password in step 1.

7 Select [Apply].

8 When prompted, unplug the LAN cable from the unit.

When the LAN cable is unplugged from the unit,  on the display turns off. When the Wi-Fi connection is established,  lights up on the display.

It may take more than 2 minutes to light up.

For information on how to listen to music with this system, refer to the Wi-Fi Startup Guide (separate document).

Note

This procedure needs to be completed within 10 minutes. If uncompleted, reset the system (page 80).

Listening to the same music from the multiple speakers

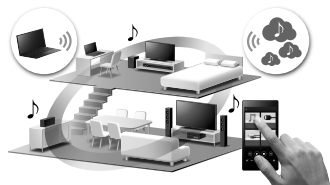

You can enjoy your favorite music stored in your PCs or mobile phones, furthermore, music from streaming services with ultimate sound quality in any rooms via Wi-Fi.

1 Install the “SongPal” application on your smartphone/iPhone.

2 Connect the system and smartphone/iPhone to your Wi-Fi network.

Connect the system and smartphone/iPhone to the same SSID (network) of your router.

3 When connecting multiple devices, connect the multi-room compatible devices to your Wi-Fi network.

Refer to Help Guide for detailed operation.

http://rd1.sony.net/help/has/mhc-v90dw/h_zz/



Enjoying the Wireless Party Chain

If you connect the multi-room compatible speakers to your Wi-Fi network and set them in the same room, you can enjoy high pressure sound like the Party Chain function via Wi-Fi. (This feature is available when playing CDDA disc and audio files of a USB device.)

Listening to an Internet music service (Chromecast built-in)

Chromecast built-in allows you to select music content from the Chromecast-enabled app and play back on the system. Chromecast built-in requires the initial setup using SongPal.

1 Install the “SongPal” application on your smartphone/iPhone.

2 Connect the system and smartphone/iPhone to your Wi-Fi network.

Connect the system and smartphone/iPhone to the same SSID (network) of your router.

3 Launch “SongPal” and download a Chromecast-enabled app.

① Launch “SongPal” then tap [MHC-V90DW] → [Settings] → [Chromecast built-in] → [Learn how to Cast].

② See the instructions, then find and install a Chromecast-enabled app on your smartphone/iPhone.

4 Launch the Chromecast-enabled app, then tap the Cast button (📶) to select “MHC-V90DW”.

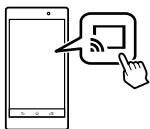

5 Select music to listen to on your Chromecast-enabled app.

The music is played on the system.

Refer to Help Guide for detailed operation.

http://rd1.sony.net/help/has/mhc-v90dw/h_zz/



Spotify Connect

Use your phone, tablet or computer as a remote control for Spotify. Go to spotify.com/connect to learn how.

After the connection is established, pressing the  MUSIC SERVICE button enables you to start/resume the music service.

Note

Depending on the country and region, music services and their periods of availability may differ.

Hint

When "Spotify Connect" is activated, the "Spotify Connect" icon (🎧) lights up.

Gesture Control**Enjoying the Gesture Control**

You can control the operations for PLAYBACK, DJ, SAMPLER and KARAOKE mode by swiping your hand over the GESTURE CONTROL sensor on the unit.

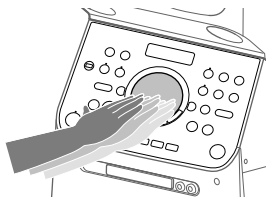
**Note**

Do not touch or contact to the GESTURE CONTROL sensor when you perform the swiping motion.

Swipe your hand over the GESTURE CONTROL sensor in 6 directions as follows.

Swiping motion	Swipe in this direction
Right to left	←
Left to right	→
Bottom to top	↑
Top to bottom	↓
Clockwise	↻
Anticlockwise	↺

To activate the Gesture Control

Touch GESTURE ON/OFF, then touch the mode you want (PLAYBACK, DJ, SAMPLER, KARAOKE).
The GESTURE CONTROL lights up.

To deactivate the Gesture Control

Touch GESTURE ON/OFF.
The GESTURE CONTROL lights off.

Using the Gesture Control during playback

You can use the Gesture Control to control basic playback when playing music from a disc, USB device or BLUETOOTH device.

Use the keys and GESTURE CONTROL sensor on the touch panel of the unit to perform this operation.

1 Touch GESTURE ON/OFF.

The GESTURE CONTROL lights up.

2 Touch PLAYBACK.

The PLAYBACK mode is activated.

3 Touch DVD/CD, USB, FM, AUDIO IN, or TV to select the function you want.

4 Swipe your hand over the GESTURE CONTROL sensor.

To	Swipe in this direction
Go backward	←
Go forward	→
Play	↑
Stop	↓
Increase volume	↻
Reduce volume	↺

Creating a party atmosphere (DJ Effect)

Use the keys and GESTURE CONTROL sensor on the touch panel of the unit to perform this operation.

1 Touch GESTURE ON/OFF.

The GESTURE CONTROL lights up.

2 Touch DJ or SAMPLER.

The DJ or SAMPLER mode is activated.

3 Swipe your hand over the GESTURE CONTROL sensor.

For DJ mode:

To	Swipe in this direction
Select FLANGER*1	←
Select ISOLATOR*2	→
Select WAH*3	↑
Select PAN*4	↓
Increase the level of the selected effect	↻
Reduce the level of the selected effect	↺

*1 Creates a deep flanging effect that is similar to the roar of a jet plane.

*2 Isolates a specific frequency band by adjusting the other frequency bands. For example, when you want to focus on vocals.

*3 Create a special effect of "Wah-wah" sound by moving the frequency of a filter up and down automatically.

*4 Create a feeling that the sound is moving around the speakers between left and right channels.

For SAMPLER mode:

To	Swipe in this direction
Output "Come On!"	←
Output "Let's Go!"	→
Output Reggae Horn sound effect	↑
Output Phaser sound effect	↓
Output Scratch sound effect	↪
Output Audience sound effect	↻

To output the SAMPLER mode sound effect

Touch SAMPLER, then touch one of the direct function key (DVD/CD, USB, FM, AUDIO IN, TV) to output the sound effect you want.

To turn off the DJ mode

Swipe your hand over the GESTURE CONTROL sensor in the same direction as in step 3 above.

Note

- The DJ Effect is automatically turned off when you:
 - turn off the system
 - change the function
 - deactivate the Gesture Control
 - change the mode to PLAYBACK/SAMPLER/KARAOKE
- If you activate the DJ Effect during transferring, the sound effect will not be transferred onto the USB device.

Using the Gesture Control during Karaoke function

Use the keys and GESTURE CONTROL sensor on the touch panel of the unit to perform this operation.

1 Touch GESTURE ON/OFF.

The GESTURE CONTROL lights up.

2 Touch KARAOKE.

The KARAOKE mode is activated.

3 Swipe your hand over the GESTURE CONTROL sensor.

To	Swipe in this direction
Reduce the pitch of music (b)	←
Increase the pitch of music (#)	→
Increase the microphone volume	↑
Decrease the microphone volume	↓
Output hand clapping sound effect	↪
Output booing sound effect	↻

Sound Adjustment

Adjusting the sound

To	Do this
Reinforce bass sound and create more powerful sound (MEGA BASS)	Press MEGA BASS repeatedly to select "BASS ON". The MEGA BASS indicator lights up. To cancel, press MEGA BASS repeatedly to select "BASS OFF".
Reproduce the sound effect of a party hall (Fiesta)	Touch FIESTA on the unit. To cancel, touch FIESTA again.
Reproduce the sound effect of a concert hall (Digital Music Arena)	Press MUSIC ARENA to select "ON". To cancel, press MUSIC ARENA again.
Select a preset sound effect (Preset sound effect)	Press SOUND FIELD repeatedly to select the sound effect you want. To cancel, press SOUND FIELD repeatedly to select "FLAT".

Selecting the Virtual Football mode

You can experience the feeling of being in the stadium when watching a football match broadcast.

Note that you can only select Virtual Football mode during AUDIO IN and TV functions.

Press SOUND FIELD repeatedly while watching a football match broadcast.

- ON NARRATION: You can enjoy an immersive feeling of being in a football stadium through enhanced stadium cheers.
- OFF NARRATION: You can enjoy a more immersive feeling of being in a football stadium by minimizing the volume level of narration in addition to the enhancement of cheers.

To cancel the Virtual Football mode

Press SOUND FIELD repeatedly to select "FLAT".

Note

- We recommend that you select the Virtual Football mode when watching a football match broadcast.
- If you hear unnatural sounds in the content when "OFF NARRATION" is selected, "ON NARRATION" is recommended.
- This feature does not support monaural sound.

Adjusting the subwoofer level

- 1 Press **OPTIONS**.
- 2 Press **▲/▼** repeatedly to select "S-WOOFER," then press **+**.
- 3 Press **▲/▼** repeatedly to select the subwoofer level, then press **+**.
To exit the options menu, press **OPTIONS**.

Creating your own sound effect

You can raise or lower the levels of specific frequency bands, then store the setting in the memory as "CUSTOM EQ".

- 1 Press **OPTIONS**.
- 2 Press **▲/▼** repeatedly to select "CUSTOM EQ", then press **+**.
- 3 Press **▲/▼** repeatedly to adjust the equalizer level, then press **+**.
- 4 Repeat step 3 to adjust the level of other frequency bands and surround effect.
To exit the options menu, press **OPTIONS**.

To select the custom equalizer setting

Press **MUSIC** repeatedly to select "CUSTOM EQ".

Other Operations

Controlling the system using a smartphone or tablet (SongPal)

"SongPal" is a dedicated app for operating "SongPal"-compatible audio devices manufactured by Sony using a smartphone or tablet. Search for "SongPal" on Google Play or App Store and download it using your smartphone or tablet.



"SongPal" allows you to:

- change the function of the system, control the playback of the disc/USB device and tune to an FM station.
- browse the music content of disc/USB device.
- view the information of disc/USB such as playing time and title.
- adjust the volume and change sound setting.

- 1 Search for "SongPal" or scan the two-dimensional code below.



- 2 Download "SongPal" app on your remote device.
- 3 Connect the system and device by **BLUETOOTH** connection (page 45) or **network connection** (page 49).

Hint

If you connect the system and remote device by network connection, connect the device by Wi-Fi to the same network as that of the system.

4 Launch “SongPal” and follow the on-screen instructions.

Note

- We recommend you to use the latest “SongPal” version.
- If the “SongPal” application does not work properly, touch BLUETOOTH on the unit to terminate the BLUETOOTH connection, then perform the BLUETOOTH connection again so that the BLUETOOTH connection functions normally.
- Available operations via “SongPal” may differ depending on the audio devices.
- For more details on “SongPal”, refer to the following URL.
<http://info.songpal.sony.net/help/>
- Specifications and display design of “SongPal” are subject to change without notice.

Getting frenzied parties with the “Fiestable” app

You can control the party features of Sony’s Home Audio System with intuitive and fancy user interface with the “Fiestable” app. “Fiestable” allows you to control features such as DJ Effect, illumination and Karaoke. Even if “Fiestable” is installed, the “Fiestable” icon is not displayed on the remote device home screen. It is embedded in the “SongPal” app as a plug-in.



1 Search and download “SongPal” app on your remote device (page 57).

2 Search and download “Fiestable” app from Google Play or App Store using your remote device.

3 Launch “SongPal” and touch the “Fiestable” icon at the top left corner.

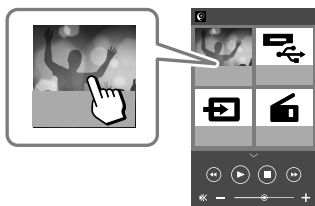

Note

- Before using “Fiestable”, turn on the BLUETOOTH function of your smartphone or tablet.
- For more details on “SongPal”, refer to the following URL.
<http://info.songpal.sony.net/help/>

Using the Control for HDMI function

Connecting a TV compatible with the Control for HDMI function* by HDMI cable (High Speed HDMI Cable with Ethernet, not supplied) enables you to easily operate the device by a TV remote control.

The following functions can be used with the Control for HDMI function.

- System Power Off function
- System Audio Control function
- Audio Return Channel
- One-Touch Play function
- Remote Easy Control

- Language Follow
- * Control for HDMI is a standard used by CEC (Consumer Electronics Control) for allowing HDMI (High-Definition Multimedia Interface) devices to control each other.

Note

These functions may work with devices other than those manufactured by Sony, but operation is not guaranteed.

Preparing to use the Control for HDMI function

Press DVD SETUP, then set [HDMI SETUP] – [CONTROL FOR HDMI] on the system to [ON] (page 40). The default setting is [ON].
Enable the Control for HDMI function settings for the TV connected to the system.

Hint

If you enable the Control for HDMI (“BRAVIA” sync) function when using a TV manufactured by Sony, the Control for HDMI function of the system is also enabled automatically. When settings are completed, “COMPLETE” appears on the display.

System Power Off function

When you turn off the TV, the system will turn off automatically.
Press DVD SETUP, then set [HDMI SETUP] – [STANDBY LINKED TO TV] on the system to [ON] or [AUTO] (page 40). The default setting is [AUTO].

Note

The connected device may not turn off depending on the status of the device.

System Audio Control function

If you turn on the system while you are watching the TV, the TV sound will be output from the speakers of the system. The volume of the system can be adjusted using the TV’s remote control.

If the TV sound was output from the speakers of the system the previous time you watched the TV, the system will be turned on automatically when you turn on the TV again. Operations can also be made by the TV’s menu. For details, refer to the operating instructions of your TV.

Note

- The system’s volume level is displayed on the TV screen depending on the TV. It may differ from the volume level on the display.
- Depending on the settings of the TV, the System Audio Control function may not be available. For details, refer to the operating instructions of your TV.

Audio Return Channel

If the system is connected to a TV’s HDMI IN jack compatible with Audio Return Channel, you can listen to TV sound from the speakers of the system without connecting an audio cable (not supplied).

On the system, press DVD SETUP, then set [HDMI SETUP] – [AUDIO RETURN CHANNEL] to [ON] (page 40). The default setting is [ON].

Note

If the TV is not compatible with Audio Return Channel, an audio cable (not supplied) needs to be connected (page 26).

One-Touch Play function

When you play video content on disc or USB device on the system, the TV is turned on automatically. The TV's input is switched to the HDMI input which the system is connected.

Note

Depending on the TV, the beginning part of content being played may not play correctly.

Remote Easy Control

You can select the system by the SYNC MENU button on the TV remote control and operate the system.

This function can be used if the TV supports the link menu. For details, refer to the operating instructions of your TV.

Note

- In the TV's link menu, the system is recognized by the TV as "Player".
- Some operations may not be available with some TVs.

Language Follow

When you change the language for the on-screen display of the TV, the system's on-screen display language is also changed.

Using the Party Chain function

You can connect multiple audio systems in a chain to create a more interesting party environment and to produce higher sound output. An activated system in the chain will be the “Party Host” and share the music. Other systems will become “Party Guests” and play the same music as that being played by the “Party Host”.

Setting up the Party Chain

Set up a Party Chain by connecting all the systems using audio cables (not supplied).

Before connecting cables, be sure to disconnect the AC power cord (mains lead).

A If all the systems are equipped with Party Chain function

Example: When connecting using this system as the first system

First system

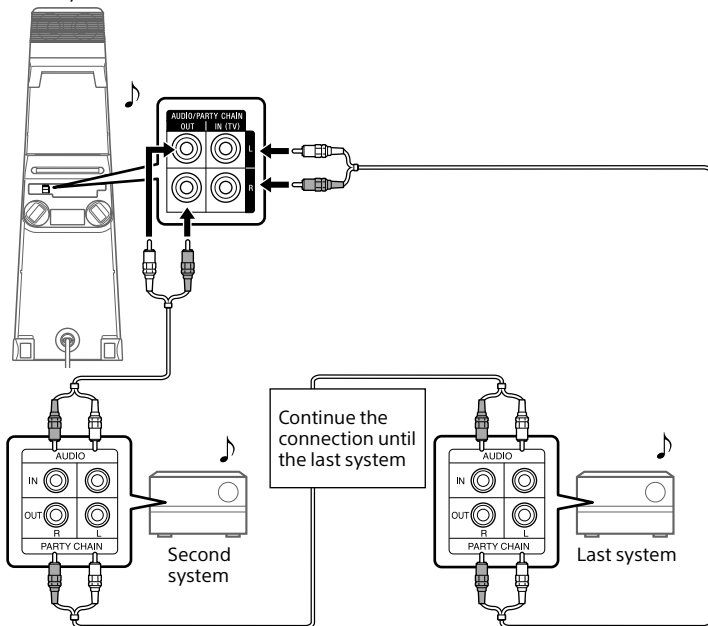

- The last system must be connected to the first system.
- Any system can become a Party Host.
- You can change the Party Host to another system in the chain. For details, see “To select a new Party Host (when all the systems are equipped with Party Chain function)” (page 63).

B If one of the systems is not equipped with Party Chain function

Example: When connecting using this system as the first system

First system

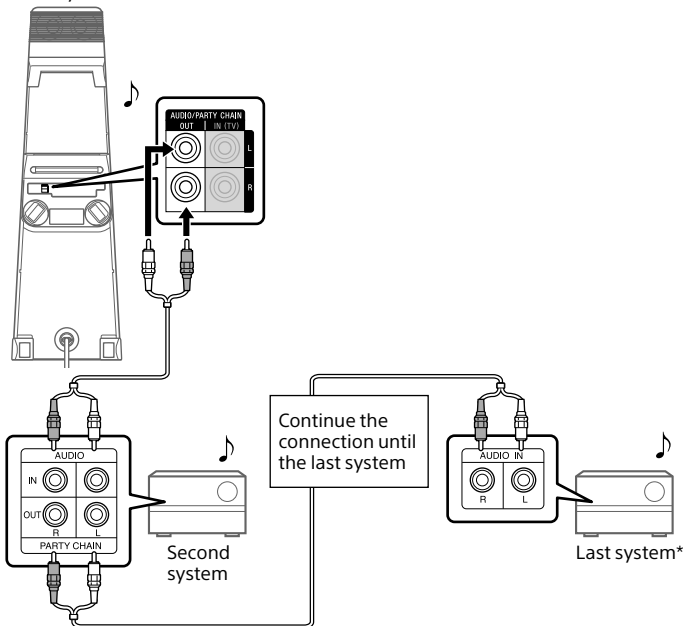

* Connect the system which is not equipped with Party Chain function at the last system, otherwise the chain will stop at that system. Be sure to select the Audio In function on this last system.

- The last system is not connected to the first system.
- You must select the first system as Party Host so that all systems are playing the same music when Party Chain function is activated.

Enjoying the Party Chain

- 1 Plug in the AC power cord (mains lead) and turn on all the systems.
- 2 Adjust the volume on each system.
- 3 Activate the Party Chain function on the system to be used as the Party Host.

Example: When using this system as the Party Host

Touch FUNCTION repeatedly on the unit to select the function you want (except when the AUDIO IN function is used in connection **A** (page 61)). Start playing the music, then touch and hold **⊖** PARTY CHAIN on the unit.

"PARTY CHAIN" appears on the display. The Party Host starts the Party Chain, and other systems become Party Guests automatically. All systems play the same music as that being played by the Party Host.

To enjoy the Wireless Party Chain

See page 51.

Note

- Depending on the total unit of systems you have connected, Party Guests may take some time to start playing the music.
- Changing the volume level and sound effect on the Party Host will not affect the output on the Party Guests.
- When you use the microphone or play the guitar on Party Host, the sound will not be output from Party Guests.
- When one of the systems in the chain is performing USB transfer, wait for the system to complete or stop the transfer before you activate the Party Chain function.

- For detailed operation on other systems, refer to the operating instructions of the systems.

To select a new Party Host (when all the systems are equipped with Party Chain function)

Repeat step 3 of "Enjoying the Party Chain" on the system to be used as a new Party Host. The current Party Host becomes Party Guest automatically. All systems play the same music as that being played by the new Party Host.

Note

- You can select another system as the new Party Host only after the Party Chain function of all the systems in the Chain has been activated.
- If the selected system does not become a new Party Host after a few seconds, repeat step 3 under "Enjoying the Party Chain".

To deactivate the Party Chain

Touch and hold **⊖** PARTY CHAIN on the Party Host.

Note

If the Party Chain function is not deactivated after a few seconds, touch and hold **⊖** PARTY CHAIN on the Party Host again.

Setting the Party Chain sound mode

You can set the sound mode when the Party Chain function is activated.

- 1 Press **OPTIONS**.
- 2 Press **↕/↕** repeatedly to select "P. CHAIN MODE", then press **⊕**.

3 Press **↑/↓** repeatedly to select the mode you want, then press .

- “STEREO”: outputs the stereo sound.
- “RIGHT CH”: outputs the monaural sound of the right channel.
- “LEFT CH”: outputs the monaural sound of the left channel.

To exit the options menu, press **OPTIONS**.

Singing along: Karaoke

Preparing for Karaoke

1 Touch **MIC/GUITAR LEVEL –** on the unit repeatedly to reduce the microphone volume level.

2 Connect an optional microphone to **MIC1** or **MIC2/GUITAR** jack on the unit.

Connect another optional microphone if you want to sing in duet.

If the **GUITAR** indicator is lit, touch **GUITAR** on the unit repeatedly until the **GUITAR** indicator lights off.

3 Start playing the music and adjust the microphone volume. Press **MIC ECHO** repeatedly to adjust the echo effect.

4 Start singing along with the music.

To use the Gesture Control during karaoke

See page 55.

Note

- Touch **MIC/GUITAR LEVEL +/-** on the unit repeatedly to adjust the microphone volume level. You cannot adjust the microphone volume level using **VOLUME +/-** on the unit or **↵ +/-** on the remote control.
- If howling occurs:
 - move the microphone away from the system.
 - change the direction of the microphone.
 - touch **MIC/GUITAR LEVEL –** on the unit repeatedly.
- Microphone sound will not be transferred to the USB device during USB transfer.

Using Vocal Fader

You can reduce the sound of the vocal in stereo source.

Touch **KARAOKE**, then touch **VOCAL FADER** on the unit repeatedly to select “**ON V.FADER**”.

To cancel Vocal Fader effect, touch **VOCAL FADER** repeatedly to select “**OFF**”.

Changing the key (Key Control)

Press **KEY CONTROL b/#** to suit your vocal range.

Activating the Karaoke scoring mode (Score Mode)

You only can use scoring function when the microphone is connected. Your score is calculated from a scale of 0 to 99 by comparing your voice with the music source.

To use the score mode, be sure to connect a microphone at least to the MIC1 jack, otherwise the score mode will not work.

For the MIC2/GUITAR jack, the score mode is available only while the guitar mode is turned off.

- 1 Start playing the music.**
- 2 Press SCORE before singing a song.**
- 3 After singing for more than a minute, press SCORE again to view your score.**

Using Voice Changer

You can change your voice when you talk or sing into microphone. There are 7 different patterns.

Touch KARAOKE, then touch VOICE CHANGER +/- on the unit repeatedly to change your voice effect.

Enjoying sound from a guitar

You can listen to the sound from the guitar by connecting a guitar to the MIC2/GUITAR jack on the unit. You can also play the guitar and sing along by connecting a microphone to the MIC1 jack on the unit.

- 1 Touch MIC/GUITAR LEVEL – on the unit repeatedly to reduce the guitar volume level.**
- 2 Use an instrument cable (not supplied) to connect a guitar (not supplied) to MIC2/GUITAR jack on the unit.**
- 3 Touch GUITAR on the unit repeatedly until GUITAR indicator lights up.**
- 4 Start playing the guitar and adjust the guitar volume.**

The guitar sound is output from the system.

Note

- If the guitar sound is distorted, reduce the guitar volume level on your guitar until the distorted sound disappears. If the guitar volume level is too low, touch MIC/GUITAR LEVEL + on the unit repeatedly to adjust the guitar volume.
- While playing the guitar, you can adjust the echo effect by pressing MIC ECHO repeatedly.

To turn off the guitar mode

Touch GUITAR on the unit repeatedly until GUITAR indicator lights off.

Enjoying music with the Party Light and Speaker Light

- 1 Press PARTY LIGHT repeatedly to select “LED ON”.**
- 2 Press LIGHT MODE repeatedly to change the illumination mode.**

To turn off Party Light and Speaker Light

Press PARTY LIGHT repeatedly to select “LED OFF”.

Note

- Do not look directly at the light-emitting part when the Party Light is turned on.
- If the illumination brightness is glaring, switch on the room lights or turn off the illumination.
- You can turn on or off the Party Light and Speaker Light when demonstration is turned on.

Using the Sleep Timer

The system turns off automatically after the preset time.

Press SLEEP repeatedly to select the time you want.

To cancel Sleep Timer, press SLEEP repeatedly to select “OFF”.

Hint

To check the remaining time before the system turns off, press SLEEP.

Using the Voice Guidance

You can hear English Voice Guidance on the following situations via the system.

- When entering BLUETOOTH pairing.
- When a BLUETOOTH device is connected.
- When a BLUETOOTH device is disconnected.
- During Wi-Fi Protected Setup™ (WPS) operation
- When a Wi-Fi network connection is established.

1 Press OPTIONS.

2 Press \uparrow/\downarrow repeatedly to select “VOICE GUIDANCE”, then press .

3 Press \uparrow/\downarrow to select “ON”, then press .

The Voice Guidance is activated. To exit the options menu, press OPTIONS.

Note

- The Voice Guidance and the SAMPLER sound effect cannot be output at the same time. If you select SAMPLER sound effect while using the Voice Guidance, the Voice Guidance will be stopped automatically, and if you use the Voice Guidance during SAMPLER sound effect output, the SAMPLER sound effect will stop automatically.
- The Voice Guidance volume level change according to the system's volume level. However, in some cases, the Voice Guidance volume level may not change.
- In some cases, there may be a delay in Voice Guidance output.

Using optional equipment

- 1 Press - repeatedly until "VOL MIN" appears on the display.
- 2 Connect an optional equipment (page 21).
- 3 Press FUNCTION +/- repeatedly to select "AUDIO IN".
- 4 Start playing the connected equipment.
- 5 Press + repeatedly to adjust the volume.

Note

The system may enter standby mode automatically if the volume level of the connected equipment is too low. Adjust the volume level of the equipment. To turn off automatic standby function, see "Setting the automatic standby function" (page 67).

Deactivating the touch panel on the unit (Child Lock)

You can deactivate the keys (except) on the touch panel of the unit to prevent misoperation, such as child mischief.

Touch and hold on the unit for more than 5 seconds.

"CHILD LOCK ON" appears on the display.

You can only operate the system using the buttons on the remote control.

To turn off the Child Lock function, touch and hold on the unit for more than 5 seconds until "CHILD LOCK OFF" appears on the display.

Note

- Child Lock function will be turned off automatically when you disconnect the AC power cord (mains lead).
- Child Lock function cannot be activated when you open the disc tray.

Setting the automatic standby function

The system enters standby mode automatically in about 15 minutes when there is no operation or audio signal output.

By default, the automatic standby function is turned on.

- 1 Press **OPTIONS**.
 - 2 Press repeatedly to select "AutoSTBY", then press .
 - 3 Press repeatedly to select "ON" or "OFF", then press .
- To exit the options menu, press **OPTIONS**.

Note

- For the models sold in Europe, to comply with the power saving regulation in Europe, products with the serial number S015503001 or later cannot use this function when the product is connected to the wired network or not connected to the wireless network. This function will not be available when the network connection is disconnected as well.
- When the multi-room function turns on, it supports TDLS (Tunneled Direct Link Setup) and works as a wireless router that improves the data communication quality.

- "AutoSTBY" flashes on the display about 2 minutes before entering standby mode.
- The automatic standby function does not work in the following cases:
 - during tuner function.
 - when the Sleep Timer is activated.
 - when microphone or Guitar is connected.

Setting the BLUETOOTH/Network standby mode

The BLUETOOTH/Network standby mode enables the system to turn on automatically when you establish a BLUETOOTH connection, a Wi-Fi connection, or a wired LAN connection.

- 1 Press OPTIONS.**
- 2 Press \uparrow/\downarrow repeatedly to select "NW STBY", then press $\boxed{+}$.**
- 3 Press \uparrow/\downarrow repeatedly to select the setting, then press $\boxed{+}$.**
 - "ON": The system turns on automatically even when the system is in standby mode.
 - "OFF": Turns off this function.To exit the options menu, press OPTIONS.

Note

- For the models sold in Europe, to comply with the power saving regulation in Europe, products with the serial number S015503001 or later cannot use this function when the product is connected to the wired network or not connected to the wireless network. This function will not be available when the network connection is disconnected as well.
- When the multi-room function turns on, it supports TDLs (Tunneled Direct Link Setup) and works as a wireless router that improves the data communication quality.

Turning on or off the BLUETOOTH/Wi-Fi signal

You can connect to the system from a linked network device or a paired BLUETOOTH device in all functions when the system's BLUETOOTH/Wi-Fi signal is set to on. The BLUETOOTH/Wi-Fi signal is turned on by default.

- 1 Press OPTIONS.**
- 2 Press \uparrow/\downarrow repeatedly to select "RF", then press $\boxed{+}$.**
- 3 Press \uparrow/\downarrow repeatedly to select the setting you want, then press $\boxed{+}$.**
 - "RF ON": Wi-Fi signal is on/ BLUETOOTH signal is on
 - "WIFI OFF": Wi-Fi signal is off/ BLUETOOTH signal is on
 - "RF OFF": Wi-Fi signal is off/ BLUETOOTH signal is offTo exit the options menu, press OPTIONS.

Note

You cannot perform the following operations when BLUETOOTH/Wi-Fi signal is set to off:

- Pairing and/or connecting with BLUETOOTH device
- Using “SongPal”

Updating the software

The software of this system may be updated in the future.

You can update your system’s pre-installed software by using one of the following 3 methods:

Automatic update via the Internet

When the system is connected to the Internet, the system updates the software automatically if a new update file is detected. This feature requires the settings to be made by using a smartphone/iPhone installed with “SongPal”.

Launch “SongPal” on your smartphone/iPhone, and set [Auto Update] in the [Settings] menu.

Refer to SongPal Help for more details.

<http://info.songpal.sony.net/help/>

Note

- For the models sold in Europe, to comply with the power saving regulation in Europe, products with the serial number S015503001 or later cannot use this function when the product is connected to the wired network or not connected to the wireless network. This function will not be available when the network connection is disconnected as well.

- When the multi-room function turns on, it supports TDLS (Tunneled Direct Link Setup) and works as a wireless router that improves the data communication quality.

Hint

Automatic update will start updating the software after downloading all the update files. So, data corruption and loss do not occur even if the network connection is unintentionally disconnected. If the error message persists, perform the manual update via a USB device.

Manual update via the Internet

When the system is connected to the Internet, “UPDATE” lights up on the display if the system detects a new update file.

- 1 Press OPTIONS.**
- 2 Press \uparrow/\downarrow repeatedly to select “SYSTEM”, then press $\boxed{+}$.**
- 3 Press \uparrow/\downarrow repeatedly to select “UPDATE”, then press $\boxed{+}$.**
- 4 Press \uparrow/\downarrow repeatedly to select “VIA NW”, then press $\boxed{+}$.**
- 5 Press \uparrow/\downarrow repeatedly to select “EXEC”, then press $\boxed{+}$.**
- 6 Press \uparrow/\downarrow repeatedly to select “YES”, then press $\boxed{+}$.**

To exit the options menu, press OPTIONS.

Manual update via a USB device

Use a computer or another device to download the update file from the websites below, then store it in a USB device. Follow the online instructions to update the software.

For customers in Latin America:

<<http://esupport.sony.com/LA>>

For customers in Europe and Russia:

<<http://www.sony.eu/support>>

**For customers in other countries/
regions:**

<[http://www.sony-asia.com/
support](http://www.sony-asia.com/support)>

Additional Information

Troubleshooting

Should you encounter a problem with your system, find your problem in the troubleshooting checklist below and take the corrective action.

If the problem persists, consult your nearest Sony dealer.

Note that if the service personnel changes some parts during repair, these parts may be retained.

If "PROTECTx CHECK MANUAL" appears on the display ("x" is a number)

Immediately unplug the AC power cord (mains lead), and check if anything is blocking the ventilation openings of the unit.

After you have checked and found no problems, reconnect the AC power cord (mains lead), and turn on the system. If the issue persists, contact your nearest Sony dealer.

General

The power does not turn on.

- Check that the AC power cord (mains lead) is connected securely.

The system cannot be turned off even though is pressed.

- You may have set the display mode to the demonstration mode unintentionally. Press DISPLAY repeatedly to select Power Saving Mode (page 29).

The system has entered standby mode.

- This is not a malfunction. The system enters standby mode automatically in about 15 minutes when there is no operation or audio signal output (page 67).

There is no sound.

- Adjust the volume.
- Check the connection of the optional equipment, if any (page 21).
- Turn on the connected equipment.
- Unplug the AC power cord (mains lead), then plug in the AC power cord (mains lead) again and turn on the system.

There is no picture/sound when connected to the HDMI OUT (TV) jack.

- Change the setting in [HDMI SETUP] – [HDMI RESOLUTION]. The problem may be solved.
- The equipment connected to the HDMI OUT (TV) jack does not conform to the audio signal format. In this case, set [HDMI SETUP] – [AUDIO(HDMI)] to [PCM] (page 40).
- Try the following:
 - Turn the system off and on again.
 - Turn the connected equipment off and on again.
 - Disconnect then connect the HDMI cable again.

There is no microphone sound.

- Adjust the microphone volume level.
- Make sure the microphone is connected to the MIC1 or MIC2/ GUITAR jack on the unit correctly.
- Make sure the microphone is turned on.

No TV sound is heard from the system.

- Check that the speaker output setting on the TV is set to use external speakers.

There is severe hum or noise.

- Move the system away from sources of noise.
- Move the system away from the neon signs or fluorescent light.
- Connect the system to a different wall outlet.
- Install a noise filter (not supplied) to the AC power cord (mains lead).
- Turn off surrounding electrical equipment.
- The noise generated by the cooling fans of the system may be heard when the system is turned on. This is not a malfunction.

The remote control does not function.

- Remove the obstacles between the remote control and the unit.
- Move the remote control closer to the unit.
- Point the remote control at the unit's sensor.
- Replace the batteries (R03/size AAA).
- Move the unit away from the fluorescent light.

There is acoustic feedback.

- Reduce the volume.
- Move the microphone or Guitar away from the system or change the direction of the microphone.

The color irregularity on a TV screen persists.

- Turn off the TV at once, then turn it on after 15 to 30 minutes. If the color irregularity still persists, place the system farther away from the TV.

"CHILD LOCK" appears when you touch any key on the unit.

- Set the Child Lock function to off (page 67).

A clicking sound is heard when turning the power on.

- This is the operating sound and it occurs when the power is turned on or off, for example. This is not a malfunction.

Disc player**The disc tray does not open and "LOCKED" appears on the display.**

- Consult your nearest Sony dealer or local authorized Sony service facility.

The disc tray does not close.

- Load the disc correctly.

The disc does not eject.

- You cannot eject the disc during Synchronized Transfer or REC1 Transfer. Press **■** to cancel the transfer, then touch **▲** on the unit to eject the disc.
- Consult your nearest Sony dealer.

Playback does not start.

- Wipe the disc clean (page 82).
- Reload the disc.
- Load the disc that this system can play back (page 9).
- Remove the disc and wipe away the moisture on the disc, then leave the system turned on for a few hours until the moisture evaporates.
- The region code on the DVD VIDEO does not match the system.

The sound skips.

- Wipe the disc clean (page 82).
- Reload the disc.
- Move the unit to a place with no vibration.

Playback does not start from the first track.

- Set the play mode to Normal Play (page 34).
- Resume Play has been selected. Press ■ twice. Then, press ► to start playback.

You cannot perform some functions such as Stop, Lock Search, Slow-motion Play, Repeat Play, or Shuffle Play.

- Depending on the disc, you may not be able to do some of the operations above. Refer to the operating instructions supplied with the disc.

The DATA CD/DATA DVD (MP3, MPEG4, or Xvid) cannot be played back.

- The data is not stored in the supported format.
- Make sure you have selected the correct Media Mode before playback.

The folder name, track name, file name and ID3 tag characters do not appear properly.

- The ID3 version is not in Version 1 (1.0/1.1) or Version 2 (2.2/2.3).
- The character codes that can be displayed by this system are as follows:
 - Upper cases (A to Z)
 - Numbers (0 to 9)
 - Symbols (< > * +, [] \ _)
 Other characters appear as “_”.

The sound loses stereo effect when you play back an AUDIO CD, VIDEO CD, audio file, video file, or DVD VIDEO.

- Turn off the Vocal Fader (page 64).
- Make sure the system is connected properly.

USB device**Transferring results in an error.**

- You are using an unsupported USB device. Check the information on the website about compatible USB devices (page 12).
- The USB device is not formatted correctly. Refer to the operating instructions of the USB device on how to format.
- Turn off the system and remove the USB device. If the USB device has a power switch, turn the USB device off and on again after removing it from the system. Then, perform the transfer again.
- If the transfer and erase operations are repeated multiple times, the file structure within the USB device becomes fragmented. Refer to the operating instructions of the USB device on how to deal with this problem.
- The USB device was disconnected or the power was turned off during transfer. Delete the partially-transferred file, and perform the transfer again. If this does not fix the problem, the USB device may be broken. Refer to the operating instructions of the USB device on how to deal with this problem.

Audio files or folders on the USB device cannot be erased.

- Check if the USB device is write-protected.
- The USB device was disconnected or the power was turned off during the erase operation. Delete the partially-erased file. If this does not fix the problem, the USB device may be broken. Refer to the operating instructions of the USB device on how to deal with this problem.

There is no sound.

- The USB device is not connected correctly. Turn off the system and reconnect the USB device, then turn on the system and check if "USB" appears on the display.

There is noise, skipping, or distorted sound.

- You are using an unsupported USB device. Check the information on the website about compatible USB devices (page 12).
- Turn off the system and reconnect the USB device, then turn on the system.
- The music data itself contains noise, or the sound is distorted. Noise may have entered during the transfer process. Delete the file, and try transfer again.
- The bit rate used in encoding an audio file was low. Send an audio file with higher bit rate to the USB device.

"READING" is displayed for an extended time, or it takes a long time before playback starts.

- The reading process can take a long time in the following cases.
 - There are many folders or files on the USB device (page 12).

- The file structure is extremely complex.
- The memory capacity is excessive.
- The internal memory is fragmented.

"NO FILE" appears on the display.

- The system has entered the software update mode, and all keys (except \odot) are deactivated. Press \odot on the unit to cancel the software update.

"OVER CURRENT" appears on the display.

- A problem has been detected with the level of electrical current from the ψ (USB) port. Unplug the AC power cord (mains lead) and remove the USB device from the port. Make sure there is no problem with the USB device. If this display pattern persists, contact your nearest Sony dealer.

Erroneous display.

- The data stored in the USB device may have been corrupted, perform the transfer again.
- The character codes that can be displayed by this system are as follows:
 - Upper cases (A to Z)
 - Numbers (0 to 9)
 - Symbols (< > * +, [] \ _)Other characters appear as " _".

The USB device is not recognized.

- Turn off the system and reconnect the USB device, then turn on the system.
- Check the information on the website about compatible USB devices (page 12).

- The USB device is not working properly. Refer to the operating instructions of the USB device on how to deal with this problem.

Playback does not start.

- Turn off the system and reconnect the USB device, then turn on the system.
- Check the information on the website about compatible USB devices (page 12).

Playback does not start from the first file.

- Set the play mode to Normal Play (page 34).

Files cannot be played back.

- Make sure you have selected the correct Media Mode before playback.
- USB devices formatted with file systems other than FAT16 or FAT32 are unsupported.*
- If you use a partitioned USB device, only files on the first partition can be played back.

* This system supports FAT16 and FAT32, but some USB devices may not support all of these FAT. For details, refer to the operating instructions of each USB device or contact the manufacturer.

Picture

There is no picture.

- Check that the system is connected securely.
- If the video cable or HDMI cable is damaged, replace it with a new one.
- Make sure you connect the unit to the HDMI input jack or the video input jack of your TV (page 25).
- Make sure you turn on the TV and operate the TV correctly.

- Make sure you select the input according to the connection on the TV so that you can view the pictures from the system.
- (Except for Latin American, European, and Russian models) Make sure you set the color system correctly, according to your TV's color system.

Picture noise appears.

- Wipe the disc clean (page 82).
- If video signal from your system has to go through your VCR to your TV, the copy-protection applied to some DVD VIDEO programs could affect the picture quality.
- (Except for Latin American, European, and Russian models) When you play back a VIDEO CD recorded in a different color system from the one you set to the system, the picture image may be distorted (pages 28, 38).
- (Except for Latin American, European, and Russian models) Set the color system to match your TV (pages 28, 38).

The aspect ratio of the TV screen cannot be changed.

- The aspect ratio is fixed on your DVD VIDEO and video file.
- Depending on the TV, you may not change the aspect ratio.

The language for the sound track cannot be changed.

- Multilingual tracks are not recorded on the DVD VIDEO being played back.
- The DVD VIDEO prohibits changing the language for the sound track.

The subtitles language cannot be changed.

- Multilingual subtitles are not recorded on the DVD VIDEO being played back.
- The DVD VIDEO prohibits changing the subtitles.

The subtitles cannot be turned off.

- The DVD VIDEO prohibits turning off subtitles.

The camera angles cannot be changed.

- Multi-angles are not recorded on the DVD VIDEO being played back.
- The DVD VIDEO prohibits changing the angles.

Tuner*

There is severe hum or noise, or stations cannot be received.

- Connect the antenna properly.
- Change antenna location and its orientation to obtain good reception.
- Turn off nearby electrical equipment.

* Radio may not be received depending on the radio wave conditions or the housing environment in your area.

BLUETOOTH device

Pairing cannot be performed.

- Move the BLUETOOTH device closer to the system.
- Pairing may not be possible if other BLUETOOTH devices are present around the system. In this case, turn off the other BLUETOOTH devices.
- Make sure to enter the correct passkey when selecting the system's name (this system) on the BLUETOOTH device.

The BLUETOOTH device cannot detect the system, or "RF OFF" appears on the display.

- Set the BLUETOOTH/Wi-Fi signal to "WIFI OFF" or "RF ON" (page 68).

Connection is not possible.

- The BLUETOOTH device you attempted to connect does not support the A2DP profile, and cannot be connected with the system.
- Enable the BLUETOOTH function of the BLUETOOTH device.
- Establish a connection from the BLUETOOTH device.
- The pairing registration information has been erased. Perform the pairing operation again.

The sound skips or fluctuates, or the connection is lost.

- The system and the BLUETOOTH device are too far apart.
- If there are obstacles between the system and your BLUETOOTH device, remove or avoid the obstacles.
- If there is equipment that generates electromagnetic radiation, such as a wireless LAN, other BLUETOOTH device, or a microwave oven nearby, move them away.

The sound of your BLUETOOTH device cannot be heard on this system.

- Increase the volume on your BLUETOOTH device first, then adjust the volume using \triangle +/-.

There is severe hum, noise, or distorted sound.

- If there are obstacles between the system and your BLUETOOTH device, remove or avoid the obstacles.
- If there is equipment that generates electromagnetic radiation, such as a wireless LAN, other BLUETOOTH device, or a microwave oven nearby, move them away.
- Turn down the volume of the connected BLUETOOTH device.

Network connection

The system cannot connect to the network. (Other equipment on the network cannot find or recognize the system.)

- Check that  is lit on the display.
- It takes about 2 minutes for the system to acquire an IP address when the system is turned on in a communication environment without a router.
- When you use a fixed IP address, the same IP address may be used by other equipment. Use a different IP address.

The system cannot connect to the network via a wireless LAN connection.

- If a network (LAN) cable is connected to the system, the system automatically operates to establish a wired LAN connection. If you wish to use a wireless LAN connection, do not connect a network (LAN) cable to the system.

- Check the settings of the wireless LAN router/access point. If the SSID stealth mode is set to “On” on the access point, set it to “Off”. For details on the settings of the access point of the wireless router, refer to the operating manual of the access point.
- Set the BLUETOOTH/Wi-Fi signal to “RF ON” (page 68).

The system cannot connect to the network using WPS.

- Set up your network after searching the access point using the access point scan.
- You cannot connect to a network using WPS when your access point is set to WEP.
- Update the firmware of the wireless LAN router/access point to the latest version.

Music Services

The system cannot connect to Music Services.

- Make sure the wireless LAN router/access point is turned on.
- Check that  is lit on the display. If not, set up a wireless network again. For details, see Wi-Fi Startup Guide.
- When the system is connected to a wireless network, place the wireless LAN/access point and the system closer together and perform the setup again.
- Depending on the providers, only one connection to Internet is allowed.
- When you turn on your mobile phone (Android device, Xperia device, or iPhone/iPod touch) after a moment of power off, try to restart the “SongPal” application.

Home Network

The controller (the operating device) cannot find this system. (The controller cannot browse the contents of this system.)

- Make sure that the controller is connected to the home network.
- The multicast control on the access point is enabled.

Music started automatically.

- This system may be controlled by another equipment. To block such control, set the BLUETOOTH/Network standby mode to off (page 68).

The sound is interrupted.

- The DLNA server is overloaded. Quit all running applications.
- The wireless signal has interference. Turn off other devices such as your microwave oven.
- The communications speed of the wireless LAN may become slower for IEEE802.11n-compliant wireless LAN routers/access points if the security method is set to WEP or WPA/WPA2-PSK (TKIP). If the speed becomes slower, change the security method to WPA/WPA2-PSK (AES). The encryption (security) scheme varies depending on the device. For details, refer to the operating instructions of your router/access point.

Tuning or playback cannot be performed.

- Confirm that the audio file is improper or has been deleted from the server. Refer to the operating instructions of the server.

- The server tries to play the audio file in an audio format that the system does not support. Check the audio format information on the server.
- Disable the multicast control on the wireless LAN router/access point. If it is enabled, it may take several minutes to output the audio. For details, refer to the operating instructions of the wireless LAN router/access point.
- The access from this system is not permitted by the server. Change the settings on the server to allow access from this system. For details, refer to the operating instructions of the server.

Gesture Control

The Gesture Control cannot be activated.

- Touch GESTURE ON/OFF repeatedly until GESTURE CONTROL lights up.
- Make sure the Child Lock function is not activated (page 67).

The Gesture Control does not operate properly.

- Move your hand closer to GESTURE CONTROL sensor (page 53) when you perform the swiping motion.
- Perform the swiping motion at a slower speed.
- Select the correct mode (PLAYBACK, DJ, SAMPLER or KARAOKE) before you start using the Gesture Control (page 54, 55).
- Install a noise filter (not supplied) to the AC power cord (mains lead).
- Turn off surrounding electrical equipment.

Control for HDMI (“BRAVIA” Sync)

The system does not turn on even when the TV is turned on.

- Press DVD SETUP, then set [HDMI SETUP] – [CONTROL FOR HDMI] to [ON] (page 40). The TV must support the Control for HDMI function (page 58). For details, refer to the operating instructions of your TV.
- Check the speaker settings of the TV. The system power syncs with the speaker settings of the TV. For details, refer to the operating instructions of your TV.
- If the sound was output from the TV’s speakers the previous time, the system does not turn on even when the TV is turned on.

The system turns off when the TV is turned off.

- Check the setting of [HDMI SETUP] – [STANDBY LINKED TO TV] (page 40). When [STANDBY LINKED TO TV] is set to [ON], the system turns off automatically when you turn off the TV regardless of the input.

The system does not turn off even when the TV is turned off.

- Check the setting of [HDMI SETUP] – [STANDBY LINKED TO TV] (page 40).
To turn the system off automatically regardless of the input when you turn off the TV, set [STANDBY LINKED TO TV] to [ON]. The TV must support the Control for HDMI function (page 58). For details, refer to the operating instructions of your TV.

No TV sound is output from the system.

- Check the type and connection of the HDMI cable or audio cable that is connected to the system and the TV (page 25).
- If your TV is compatible with Audio Return Channel, make sure the system is connected to an ARC-compatible HDMI IN jack of the TV (page 25). If sound is still not output or if sound is interrupted, connect an audio cable (not supplied) and press DVD SETUP, then set [HDMI SETUP] – [AUDIO RETURN CHANNEL] to [OFF] (page 40).
- If your TV is not compatible with Audio Return Channel, TV sound will not be output from the system even if the system is connected to the TV’s HDMI IN jack. To output TV sound from the system, connect an audio cable (not supplied) (page 26).
- Switch input of the system to “TV” (page 26).
- Increase the volume on the system.
- Depending on the order in which you connect the TV and the system, the system may be muted and “MUTING” lights up in display panel of the system. If this happens, turn on the TV first, then the system.
- Set the speakers setting of the TV (BRAVIA) to Audio System. Refer to the operating instructions of your TV on how to set the TV.

The sound is output from both the system and the TV.

- Mute the sound of the system or the TV.
- Change the speaker output on the TV to TV speaker or Audio System.

The Control for HDMI function does not work properly.

- Check the connection with the system (page 21).
- Enable the Control for HDMI function on the TV. For details, refer to the operating instructions of your TV.
- Wait a while, then try again. If you unplug the system, it will take a while before operations can be made. Wait for 15 seconds or longer, then try again.
- Make sure the TV connected to the system support the Control for HDMI function.
- The type and number of devices that can be controlled by the Control for HDMI function is restricted by the HDMI CEC standard as follows:
 - Recording devices (Blu-ray Disc recorder, DVD recorder, etc.): up to 3 devices
 - Playback devices (Blu-ray Disc Player, DVD player, etc.): up to 3 devices (this system uses one of them)
 - Tuner-related devices: up to 4 devices
 - Audio system (receiver/headphone): up to 1 device (used by this system)

Party Chain

Party Chain function cannot be activated.





- Check the connections (page 61).
- Make sure the audio cables are connected correctly.

Party Chain function does not work properly.

- Turn off the system. Then, turn it back on again to activate the Party Chain function.

Resetting the system

If the system still does not operate properly, reset the system to factory default settings.

- 1 Unplug the AC power cord (mains lead), then plug it back in.
- 2 Press  to turn on the system.
- 3 Press **OPTIONS**.
- 4 Press **▲/▼** repeatedly to select "SYSTEM", then press .
- 5 Press **▲/▼** repeatedly to select "RESET", then press .
- 6 Press **▲/▼** repeatedly to select "YES", then press .



"RESET" appears on the display.

After the reset completes, the system automatically reboots. Press  to turn on the system.

All user-configured settings, such as preset radio stations and Sleep Timer are reset to factory default setting.

Returning the setup menu settings to the default

You can return the setup menu settings (except for [PARENTAL CONTROL] settings) to the default settings.

- 1 Press **DVD SETUP**.
The setup menu appears on the TV screen.
- 2 Press **▲/▼** repeatedly to select [SYSTEM SETUP], then press .
- 3 Press **▲/▼** repeatedly to select [RESET], then press .

- 4 Press **↑/↓** repeatedly to select [YES], then press **+**.
It takes a few seconds to complete. Do not press **⏻** while resetting the system.

Self-diagnosis Function

When letters/numbers appear on the TV screen or the display

When the self-diagnosis function is activated to prevent the system from malfunctioning, a service number appears. The service number consists of an alphabet and numerals (e.g. C 13 50). See the following table for the cause and corrective action.

First 3 characters of the service number	Cause and corrective action
C 13	This disc is dirty. <ul style="list-style-type: none"> Clean the disc with a soft cloth (page 82).
C 31	The disc is not inserted correctly. <ul style="list-style-type: none"> Turn off the system, then turn it back on again. Then re-insert the disc correctly.
E XX (XX is a number)	To prevent a malfunction, the system has performed the self-diagnosis function. <ul style="list-style-type: none"> Contact your nearest Sony dealer or local authorized Sony service facility and give the 5-character service number. Example: E 61 10

Messages

One of the following messages may appear or flash on the display during operation.

CANNOT PLAY

- A disc that cannot be played back was inserted.
- A DVD VIDEO with unsupported region code was inserted.

DATA ERROR

- The file is created in unsupported format.
- The file extensions does not match the file format.

DEVICE ERROR

The USB device could not be recognized or an unknown device is connected.

DEVICE FULL

The memory of the USB device is full.

ERASE ERROR

Erase of audio files or folders on the USB device failed.

FATAL ERROR

The USB device was removed during transfer or erase operation, and may have been damaged.

FOLDER FULL

You cannot transfer onto the USB device because the number of folders has reached its maximum.

GUEST

The system has become a Party Guest as the Party Chain function has been activated by a Party Host.

GROUP

The system has joined in the Wireless Party Chain activated by a Wireless Party Chain Host.

HOST

The system activated the Party Chain function and has become a Party Host.

M-ROOM

The system activated the Wireless Party Chain function and has become a Wireless Party Chain Host.

NoDEVICE

No USB device is connected or unsupported device is connected.

NO DISC

There is no disc in the player.

NO MUSIC

No supported audio files exist in the playback source.

NO SUPPORT

An unsupported USB device is connected, or the USB device is connected through a USB hub.

NO VIDEO

No supported video files exist in the playback source.

NOT USE

You tried to perform a specific operation under conditions where that operation is prohibited.

OVER CURRENT

An over current from the Ψ (USB) port was detected.

PROTECT

The USB device is write-protected.

PUSH STOP

You tried to perform an operation that can be performed only when the playback is stopped.

READING

The system is reading information of the disc or USB device. Some operations are not available.

REC ERROR

The transfer did not start, stopped partway, or otherwise could not be performed.

TRACK FULL

You cannot transfer onto the USB device because the number of files has reached its maximum.

Precautions

When carrying the unit

To avoid damaging the disc mechanism, perform the following procedure before carrying the unit.

Use the keys on the touch panel of the unit to perform this operation.

1 Press \odot to turn on the system.

2 Touch **FUNCTION** repeatedly to select "DVD/CD".

3 Remove the disc.

Touch \blacktriangle to open and close the disc tray.

Wait until "NO DISC" appears on the display.

4 Unplug the AC power cord (mains lead).

Notes on discs

- Before playing, wipe the disc with a cleaning cloth from the center outward to the edge.
- Do not clean discs with solvents, such as benzene, thinner, or commercially available cleaners or anti-static spray intended for vinyl LPs.
- Do not expose discs to direct sunlight or heat sources such as hot air ducts, nor leave them in a car parked in direct sunlight.

On safety

- Completely disconnect the AC power cord (mains lead) from the wall outlet (mains) if it is not going to be used for an extended period of time. When unplugging the system, always grip the plug. Never pull the cord itself.
- Should any solid object or liquid get into the system, unplug the system, and have it checked by qualified personnel before operating it again.
- AC power cord (mains lead) must be changed only at the qualified service shop.

On placement

- Do not place the system in an inclined position or in locations that are extremely hot, cold, dusty, dirty, or humid or lacking adequate ventilation, or subject to vibration, direct sunlight or a bright light.
- Be careful when placing the system on surfaces that have been specially treated (for example, wax, oil, polish) as staining or discoloration of the surface may result.
- If the system is brought directly from a cold to a warm location or is placed in a very damp room, moisture may condense on the lens inside the unit, and cause the system to malfunction. In this situation, remove the disc, and leave the system turned on for about an hour until the moisture evaporates.

On heat buildup

- Heat buildup on the unit during operation is normal and is not a cause for alarm.
- Do not touch the cabinet if it has been used continuously at a high volume because the cabinet may have become hot.
- Do not obstruct the ventilation holes.

On the speaker system

The built-in speaker system is not magnetically shielded, and the picture on nearby TV sets may become magnetically distorted. In this situation, turn off the TV, wait 15 to 30 minutes, and turn it back on. If there is no improvement, move the system far away from the TV.

IMPORTANT NOTICE

Caution: If you leave a still video image or on-screen display image displayed on your TV for an extended period of time via this system, you risk permanent damage to your TV screen. Projection TVs are especially susceptible to this.

Cleaning the cabinet

Clean this system with a soft cloth slightly moistened with a mild detergent solution. Do not use any type of abrasive pad, scouring powder, or solvent, such as thinner, benzine, or alcohol.

Notes on updating

This system allows you to update the software automatically when connected to the Internet via a wired or wireless network.

You can add new features and use the system with more convenience and safety by updating the system. If you do not want to update automatically, you can disable the function by using SongPal installed on your smartphone/iPhone. However, the system may update the software automatically for reasons such as safety, even if this function is disabled. You can also update the software using the settings menu when this function is disabled. See "Updating the software" (page 69) for details. You may not use the system while the software is being updated.

Disclaimer regarding services offered by third parties

Services offered by third parties may be changed, suspended, or terminated without prior notice. Sony shall not be held responsible in these situations.

On BLUETOOTH communication

- BLUETOOTH devices should be used within approximately 10 meters (unobstructed distance) of each other. The effective communication range may become shorter under the following conditions.
 - When a person, metal object, wall or other obstruction is between the devices with a BLUETOOTH connection
 - Locations where a wireless LAN is installed
 - Around microwave ovens that are in use
 - Locations where other electromagnetic waves are generated
- BLUETOOTH devices and wireless LAN (IEEE 802.11b/g/n) equipment use the same frequency band (2.4 GHz). When using your BLUETOOTH device near a device with wireless LAN capability, electromagnetic interference may occur. This could result in lower data transfer rates, noise, or inability to connect. If this happens, try the following remedies:
 - Use this system at least 10 meters away from the wireless LAN equipment.
 - Turn off the power of the wireless LAN equipment when using your BLUETOOTH device within 10 meters.
 - Use this system and BLUETOOTH device as closer to each other as possible.
- The radio waves broadcast by this system may interfere with the operation of some medical devices. Since this interference may result in malfunction, always turn off the power on this system and BLUETOOTH device in the following locations:

- In hospitals, on trains, in airplanes, at gas stations, and any place where flammable gases may be present
- Near automatic doors or fire alarms
- This system supports security functions that comply with BLUETOOTH specifications to ensure secure connections during communication using BLUETOOTH technology. However, this security may be insufficient depending on the setting contents and other factors, so always be careful when performing communication using BLUETOOTH technology.
- Sony cannot be held liable in any way for damages or other loss resulting from information leaks during communication using BLUETOOTH technology.
- BLUETOOTH communication is not necessarily guaranteed with all BLUETOOTH devices that have the same profile as this system.
- BLUETOOTH devices connected with this system must comply with the BLUETOOTH specification prescribed by the Bluetooth SIG, Inc., and must be certified to comply. However, even when a device complies with the BLUETOOTH specification, there may be cases where the characteristics or specifications of the BLUETOOTH device make it impossible to connect, or may result in different control methods, display or operation.
- Noise may occur or the audio may cut off depending on the BLUETOOTH device connected with this system, the communications environment, or surrounding conditions.

Notes on the License

This product contains software that Sony uses under a licensing agreement with the owner of its copyright. We are obligated to announce the contents of the agreement to customers under requirement by the owner of copyright for the software.

Please access the following URL and read the contents of the license.
<http://rd1.sony.net/help/has/sl/16/>



Notice on GNU GPL/LGPL applied software

This product contains software that is subject to the following GNU General Public License (hereinafter referred to as "GPL") or GNU Lesser General Public License (hereinafter referred to as "LGPL"). These establish that customers have the right to acquire, modify, and redistribute the source code of said software in accordance with the terms of the GPL or LGPL supplied. The source code for the above-listed software is available on the Web.

To download, please access the following URL then select the model name "MHC-V90DW".

URL: <http://oss.sony.net/Products/Linux/>

Please note that Sony cannot answer or respond to any inquiries regarding the content of the source code.

Notes on the update

If you use this unit while connected to the Internet via a wired or Wi-Fi network, the unit can update to the latest software automatically.

By updating the software, new features will be added enabling you to experience more convenient and stable use.

If you do not want to automatically update the software, you can disable this

function by using the SongPal installed on your smartphone/iPhone. However, the software may be updated automatically for stable use, etc., even if you disable this function. Also, if you disable this function, you can still update the software manually. For details about how to set and operate, refer to the Help Guide. The unit may not be operational while updating.

Disclaimer regarding services offered by third parties

Services offered by third parties may be changed, suspended, or terminated without prior notice. Sony does not bear any responsibility in these sorts of situations.

About Software version

This radio equipment is intended to be used with the approved version(s) of software that are indicated in the EU Declaration of Conformity. The software loaded on this radio equipment is verified to comply with the essential requirements of the Directive 2014/53/EU.

Software version: SYS_ _ _ _

You can check the software version by pressing OPTIONS on the remote control.

- 1 Press OPTIONS.**
- 2 Press \uparrow/\downarrow repeatedly to select the system, then press $\boxed{+}$.**
- 3 Select "VERSION", then press $\boxed{+}$.**
"SYS_ _ _ _" appears on the display.

Specifications

Satellite unit (Speaker System SS-V90DW)

Speaker system:

Tweeter + Midrange speaker

Speaker unit:

Tweeter: 50 mm × 4, cone type

Midrange: 130 mm × 4, cone type

Rated impedance:

8 ohm

Subwoofer unit (DVD Receiver SA-V90DW)

Speaker system:

Subwoofer, bass reflex

Speaker unit:

250 mm × 2, cone type

Rated impedance:

8 ohm

Inputs

AUDIO/PARTY CHAIN IN (TV) L/R:

Voltage 2 V, impedance

47 kilohms

TV (ARC):

Supported audio signal:

2-channel Linear PCM

MIC1:

Sensitivity 1 mV, impedance

10 kilohms

MIC2/GUITAR:

Sensitivity 1 mV, impedance

10 kilohms (When guitar mode is turned off.)

Sensitivity 200 mV, impedance

1 Megaohm (When guitar mode is turned on.)

Outputs

AUDIO/PARTY CHAIN OUT L/R:

Voltage 2 V, impedance 1 kilohm

VIDEO OUT:

Max. output level 1 Vp-p, unbalanced, Sync. negative load impedance 75 ohms

HDMI OUT (TV):

Supported audio signal:

2-channel Linear PCM (up to 48 kHz), Dolby Digital

HDMI section

Connector:

Type A (19 pin)

Disc player section

System:

Compact disc and digital audio and video system

Laser Diode Properties

Emission Duration: Continuous

Laser Output*: Less than 44.6 μ W

* This output is the value measurement at a distance of 200 mm from the objective lens surface on the Optical Pick-up Block with 7 mm aperture.

Frequency response:

20 Hz – 20 kHz

Video color system format:

Latin American model:

NTSC

Other models:

NTSC and PAL

USB section

Supported USB device:

Mass Storage Class

Maximum current:

1 A

⚡ (USB) port:

Type A

FM tuner section

FM stereo, FM superheterodyne tuner

Antenna:

FM lead antenna

Tuning range:

87.5 MHz – 108.0 MHz (50 kHz step)

BLUETOOTH section

Communication system:

BLUETOOTH Standard version 4.2

Output:

BLUETOOTH Standard Power Class 1

Maximum communication range:

Line of sight approx. 30 m^{*1}

Operating frequency:

2400 - 2483.5 MHz

Maximum output power:

< 20.0 dBm

Modulation method:

FHSS (Freq Hopping Spread Spectrum)

Compatible BLUETOOTH profiles^{*2}:

A2DP (Advanced Audio Distribution Profile)

AVRCP (Audio Video Remote Control Profile)

SPP (Serial Port Profile)

Supported codecs:

SBC (Subband Codec)

AAC (Advanced Audio Coding)

LDAC

^{*1} The actual range will vary depending on factors such as obstacles between devices, magnetic fields around a microwave oven, static electricity, reception sensitivity, antenna's performance, operating system, software application, etc.

^{*2} BLUETOOTH standard profiles indicate the purpose of BLUETOOTH communication between devices.

Network section

Ethernet LAN

100BASE-TX

Wireless LAN

Compatible standards:

IEEE 802.11 a/b/g/n

Security:

WPA/WPA2-PSK, WEP

Operating frequency:

2400 - 2483.5 MHz/

5150 - 5250 MHz/

5250 - 5350 MHz/

5470 - 5725 MHz

Maximum output power:

< 20.0 dBm

Operating frequency:

5725 - 5850 MHz

Maximum output power:

< 13.9 dBm

NFC section

Operating frequency:

13.56 MHz

Maximum output power:

< 60 dBμA/m at 10 m

Supported audio formats

Supported bit rate and sampling frequencies:

MP3:

16/22.05/24/32/44.1/48 kHz,

16 kbps – 320 kbps (CBR/VBR)

AAC:

16/22.05/24/32/44.1/48/88.2/

96 kHz, 16 kbps – 320 kbps (CBR/

VBR)

WMA:

32/44.1/48 kHz, 16 kbps –

320 kbps (CBR/VBR)

WAV:

16/22.05/24/32/44.1/48/88.2/

96/176.4/192 kHz (16/24 bit)

AIFF:

32/44.1/48/88.2/96/176.4/

192 kHz (16/24 bit)

FLAC:
16/22.05/24/32/44.1/48/88.2/
96/176.4/192 kHz (16/24 bit)
ALAC:
16/22.05/24/32/44.1/48/88.2/
96/176.4/192 kHz (16/24 bit)
DSD (DSF/DFF):
2.8 MHz (1 bit)

Supported video formats

Xvid:

Video codec: Xvid video
Bit rate: 4.854 Mbps (MAX)
Resolution/Frame rate:
720 × 480, 30 fps
720 × 576, 25 fps (except for Latin
American model)
Audio codec: MP3

MPEG4:

File format: MP4 File Format
Video codec: MPEG4 Simple
Profile (AVC is not compatible.)
Bit rate: 4 Mbps
Resolution/Frame rate:
720 × 480, 30 fps
720 × 576, 25 fps (except for Latin
American model)
Audio codec: AAC-LC (HE-AAC is
not compatible.)
DRM: Not compatible

General

Power requirements:

AC 120 V – 240 V, 50/60 Hz

Power consumption:

320 W

Power consumption (at the Power Saving mode):

0.5 W (When "NW STBY" is set to "OFF" and [CONTROL FOR HDMI] is set to [OFF].)

3.0 W* (When "NW STBY" is set to "ON" and [CONTROL FOR HDMI] is set to [ON].)

3.0 W (all terminals and networks connected) (For the models sold in Europe with the serial number S015503001 or later)

Dimensions (W/H/D) (Approx.):

Assembled unit:

532 mm × 1,706 mm ×
494 mm

Satellite unit:

429 mm × 830 mm × 344 mm

Subwoofer unit:

532 mm × 1,080 mm ×
494 mm

Mass (Approx.):

Assembled unit:

50.5 kg

Satellite unit:

13.5 kg

Subwoofer unit:

37 kg

* The power consumption of the system will be less than 0.5 W when there is no HDMI connection and "NW STBY" is set to "OFF".

Note

- Wi-Fi port has a router function which can forward audio data to other Sony audio products.
- When the multi-room function turns on, it supports TDLS (Tunneled Direct Link Setup) and works as a wireless router that improves the data communication quality.

Design and specifications are subject to change without notice.

Language code list

The language spellings conform to the ISO 639:1988 (E/F) standard.

Code	Language	Code	Language	Code	Language	Code	Language
1027	Afar	1186	Scots Gaelic	1350	Malayalam	1513	Siswati
1028	Abkhazian	1194	Galician	1352	Mongolian	1514	Sesotho
1032	Afrikaans	1196	Guarani	1353	Moldavian	1515	Sundanese
1039	Amharic	1203	Gujarati	1356	Marathi	1516	Swedish
1044	Arabic	1209	Hausa	1357	Malay	1517	Swahili
1045	Assamese	1217	Hindi	1358	Maltese	1521	Tamil
1051	Aymara	1226	Croatian	1363	Burmese	1525	Telugu
1052	Azerbaijani	1229	Hungarian	1365	Nauru	1527	Tajik
1053	Bashkir	1233	Armenian	1369	Nepali	1528	Thai
1057	Byelorussian	1235	Interlingua	1376	Dutch	1529	Tigrinya
1059	Bulgarian	1239	Interlingue	1379	Norwegian	1531	Turkmen
1060	Bihari	1245	Inupiak	1393	Occitan	1532	Tagalog
1061	Bislama	1248	Indonesian	1403	(Afan) Oromo	1534	Setswana
1066	Bengali; Bangla	1253	Icelandic	1408	Oriya	1535	Tonga
1067	Tibetan	1254	Italian	1417	Punjabi	1538	Turkish
1070	Breton	1257	Hebrew	1428	Polish	1539	Tsonga
1079	Catalan	1261	Japanese	1435	Pashto; Pushto	1540	Tatar
1093	Corsican	1269	Yiddish	1436	Portuguese	1543	Twi
1097	Czech	1283	Javanese	1463	Quechua	1557	Ukrainian
1103	Welsh	1287	Georgian	1481	Rhaeto-Romance	1564	Urdu
1105	Danish	1297	Kazakh	1482	Kirundi	1572	Uzbek
1109	German	1298	Greenlandic	1483	Romanian	1581	Vietnamese
1130	Bhutani	1299	Cambodian	1489	Russian	1587	Volapük
1142	Greek	1300	Kannada	1491	Kinyarwanda	1613	Wolof
1144	English	1301	Korean	1495	Sanskrit	1632	Xhosa
1145	Esperanto	1305	Kashmiri	1498	Sindhi	1665	Yoruba
1149	Spanish	1307	Kurdish	1501	Sangho	1684	Chinese
1150	Estonian	1311	Kirghiz	1502	Serbo-Croatian	1697	Zulu
1151	Basque	1313	Latin	1503	Singhalese	1703	Not specified
1157	Persian	1326	Lingala	1505	Slovak		
1165	Finnish	1327	Laothian	1506	Slovenian		
1166	Fiji	1332	Lithuanian	1507	Samoan		
1171	Faroese	1334	Latvian; Lettish	1508	Shona		
1174	French	1345	Malagasy	1509	Somali		
1181	Frisian	1347	Maori	1511	Albanian		
1183	Irish	1349	Macedonian	1512	Serbian		

Parental Control area code list

Code	Area	Code	Area	Code	Area	Code	Area
2044	Argentina	2165	Finland	2362	Mexico	2149	Spain
2047	Australia	2174	France	2376	Netherlands	2499	Sweden
2046	Austria	2109	Germany	2390	New Zealand	2086	Switzerland
2057	Belgium	2248	India	2379	Norway	2528	Thailand
2070	Brazil	2238	Indonesia	2427	Pakistan	2184	United Kingdom
2079	Canada	2254	Italy	2424	Philippines		
2090	Chile	2276	Japan	2436	Portugal		
2092	China	2304	Korea	2489	Russia		
2115	Denmark	2363	Malaysia	2501	Singapore		

<https://www.sony.net/>



HDMI



MP3



* 4 6 9 4 8 4 1 3 9 * (1)