



www.vava.com

ASIA PACIFIC

E-mail: support.jp@sunvalley.co.jp

Tel: 03-5542-0238 (10-18時/土日祝日を除く)

JP Importer: 株式会社SUNVALLEY JAPAN

Address: 〒104-0032東京都中央区八丁堀3丁目18-6 PMO京橋東9F

EUROPE

E-mail: europe@sunvalley-group.de

EU Importer: ZBT International Trading GmbH

Address: Halstenbeker Weg 98C, 25462 Rellingen, Deutschland

NORTH AMERICA

E-mail: support@vava.com

Tel: 1-888-456-8468 (Monday-Friday: 9:00 – 17:00 PST)

US Distributor: SUNVALLEYTEK INTERNATIONAL INC.

Address: 46724 Lakeview Blvd, Fremont, CA 94538

MANUFACTURER

Shenzhen NearbyExpress Technology Development Co.,Ltd.

Address: 333 Bulong Road, Shenzhen, China, 518129

Learn more about the EU Declaration of Conformity: www.vava.com

MADE IN CHINA

V1.4



MODEL: VA-IH006BU, VA-IH006PU
BABY MONITOR
User Guide

CONTENTS

SAFETY INSTRUCTIONS	01
CAUTION	01
PACKAGE CONTENTS	02
PRODUCT DIAGRAM	03
GETTING STARTED	05
1. Charging & Powering Baby Monitor	05
2. Powering Camera	05
3. Pairing the Baby Monitor & the Camera	05
4. Placing the Camera	06
5. Wall Mounting Camera	06
6. Wide-Angle Lens (Optional)	07
FUNCTIONS & OPERATIONS	08
Monitor Interface Overview	08
1. Monitor Settings	09
2. Add / View / Delete a Camera	10
3. Digital Zoom & Circulating	10
4. Pan-n-Tilt	11
5. Volume Adjustment	11
6. Night Vision	11
7. Alarm	11
8. Talkback	12
9. Wide-angle Viewing (Optional)	12
10. Temperature Alert	12
SPECIFICATIONS	13
TROUBLESHOOTING	15
WARRANTY & CUSTOMER SERVICE	16
FCC STATEMENT	17
IC STATEMENT	19

SAFETY INSTRUCTIONS

- Keep cord out of the reach of children (more than 3ft / 0.9m away) in case of STRANGULATION.

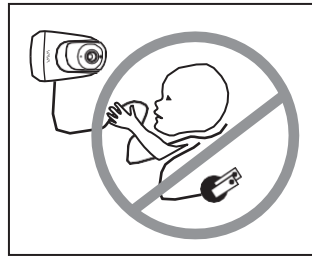
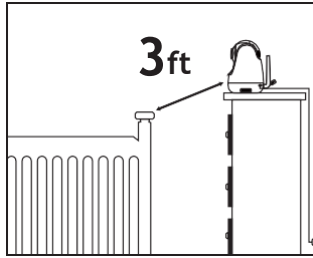

- NEVER place the camera or cord in or near the crib or playpen.
- NEVER mount the camera directly above the crib or playpen to avoid the risk of injury.
- Only use the AC adapters provided.
- Never use the unit near water, including near a bathtub, sink, laundry machine tube, wet basement, etc.
- Do not install near any heat sources such as radiators, heat registers, stoves, or other devices that produce heat.
- Only use attachments and accessories specified by the manufacturer.
- Unplug this device when unused for long periods of time.
- Do not insert anything into the upgrade pinholes. This operation is only intended for professionals.

CAUTION

- NOT toys. Do not allow children to play with them.
- The lens and lens hood are small parts, keep them out of your baby's reach at all times.
- This product is NOT intended to replace the proper supervision of children. You MUST check your child's activity regularly.
- This product is not intended for use as a medical camera and its use should not replace adult supervision.
- Unplug the product during lightning storms.
- Please check the operating range and condition of the camera carefully at

- the initial installation, and on a regular basis after that.
- Check the reception regularly. Test the camera before use and after changing the camera's location.
- For indoor use only.
- Clean the camera with a dry cloth only.
- Do not block any ventilation openings.
- Microphone feedback might occur when the monitor is too close to the camera. Please keep them at least 1.5m / 4.9ft apart.

PACKAGE CONTENTS

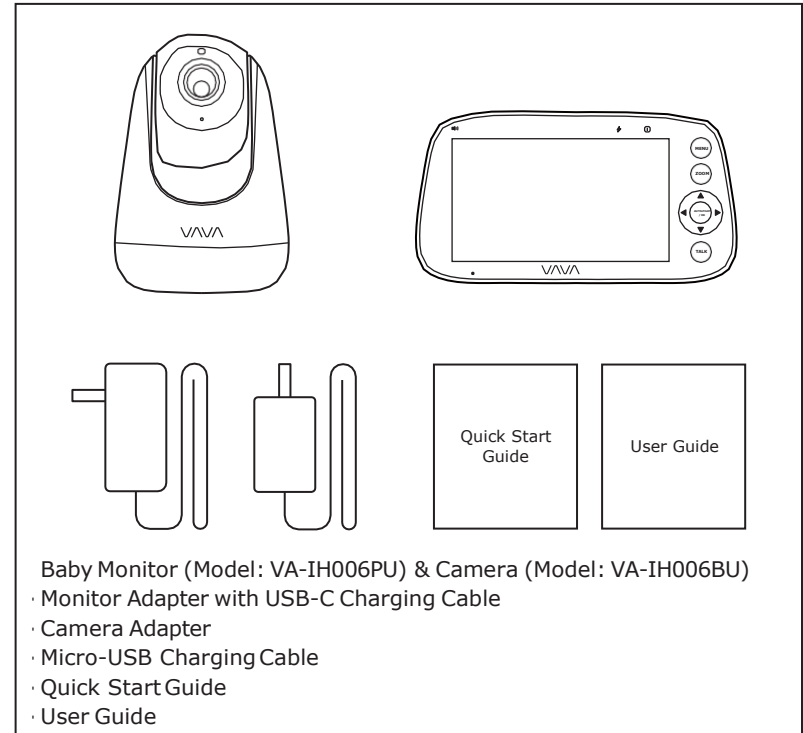

PRODUCT DIAGRAM

Baby Monitor

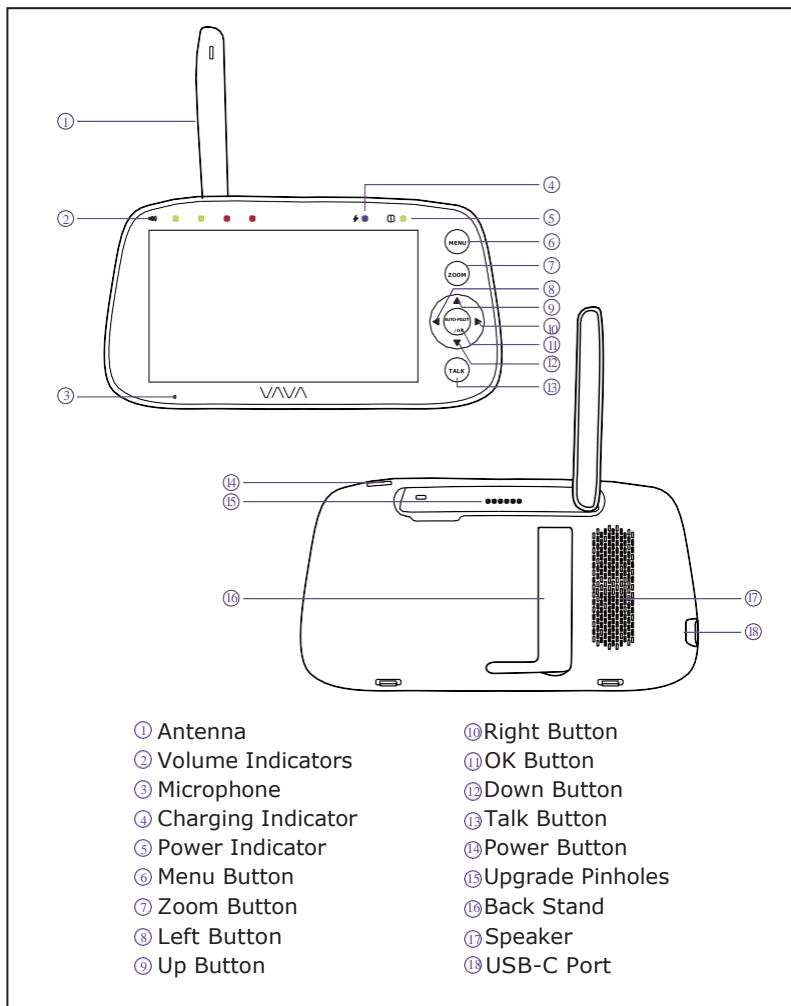

Camera

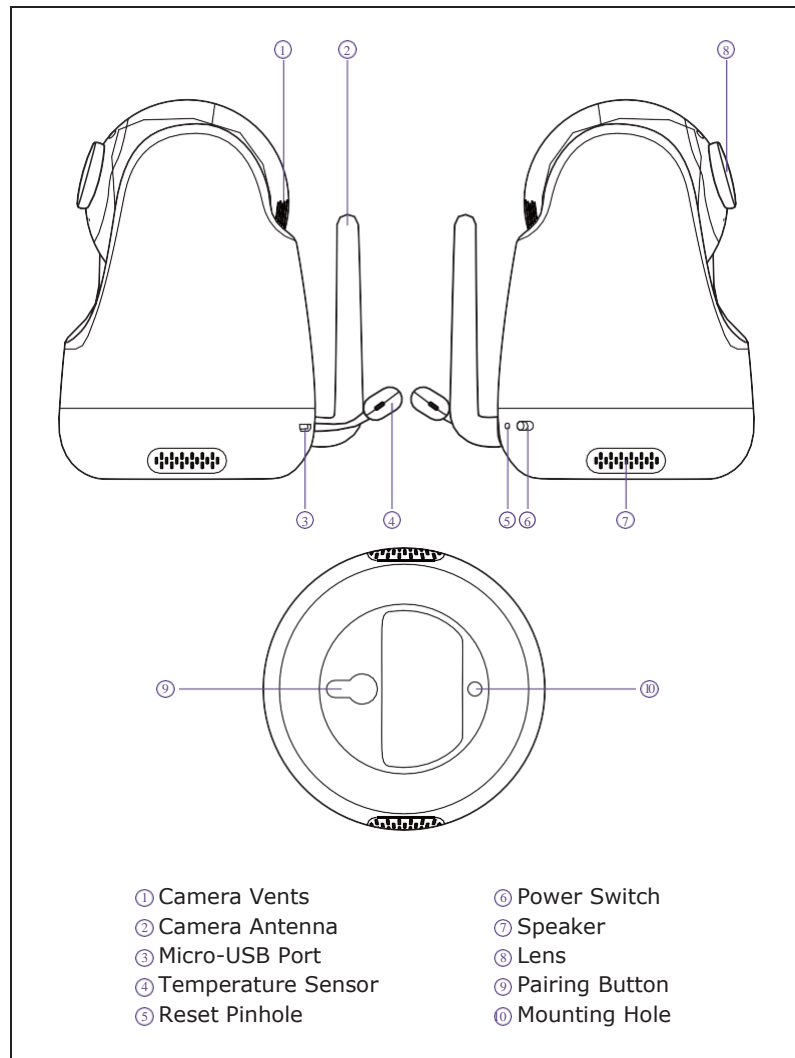

GETTING STARTED

1. Charging & Powering Baby Monitor

- 1) Connect the monitor adapter to the monitor and a power outlet.
- 2) Unplug the unit when its power indicator turns off, indicating a full charge.
- 3) Press the Power button on the monitor to power on with the power indicator lighting green.

2. Powering Camera

- 1) Connect the camera to power source via the Micro-USB cable and camera adapter.
- 2) Slide the Power Switch on camera to power on. Make sure the power indicator light is green.



- Only use the power adapters included in the package.
- Do not place the camera and power cord within the reach of your baby.

3. Pairing the Baby Monitor & the Camera

By default, one camera has been paired with the monitor when manufactured. When you power on the monitor and camera, the two will automatically pair. To add more cameras, press the Pair Button at the bottom of the camera, press Menu button, select through -> -> , and then the monitor will auto-pair with the camera.



- Once they're paired successfully, the camera number with icon 1 will be shown at the top left.
- Microphone feedback might occur when the monitor is too close to the camera. Please keep them at least 1.5m / 4.9ft apart.
- It is recommended to pair in the baby's room, or wherever you intend to place the camera.

4. Placing the Camera

Place the camera 1.5-2m / 4.9-6.6ft away from your baby for safety reason and for a better view when in night vision mode.

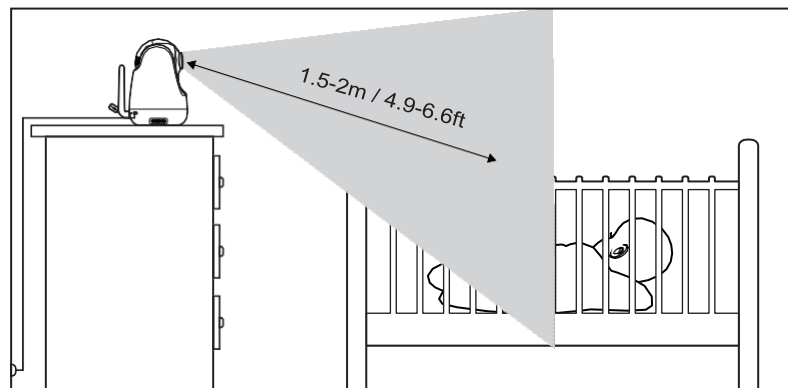

5. Wall Mounting Camera

- 1) Select the spot to mount the camera, keeping it beyond your baby's reach.
- 2) Insert the screw (not included) pre-installed on wall into the mounting hole of the camera.

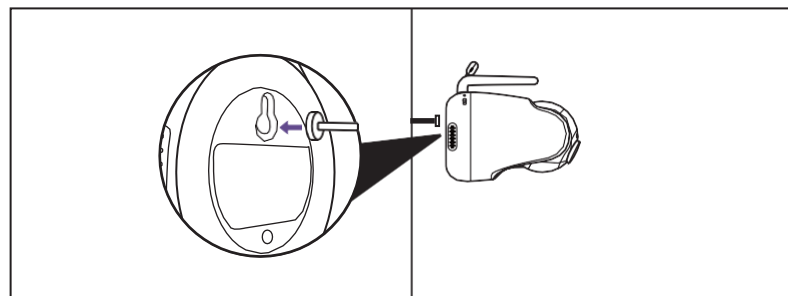

It's strongly recommended to use a screw and screw anchor. Don't release the camera until you're sure it is firmly mounted.

6. Wide-Angle Lens (Optional)

The aluminum lens hood (no special video effects) has been installed when the camera was manufactured.

To install wide-angle lens (sold separately), simply rotate the original lens hood counterclockwise to remove. Then install the new lens and rotate clockwise to fix in place.

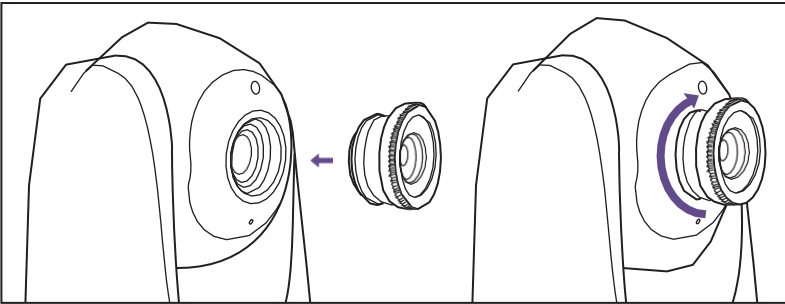
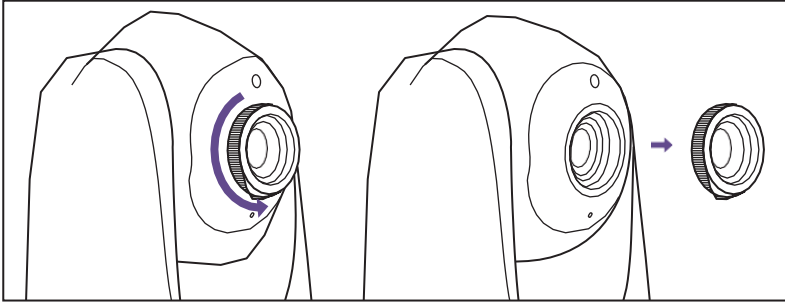

FUNCTIONS & OPERATIONS



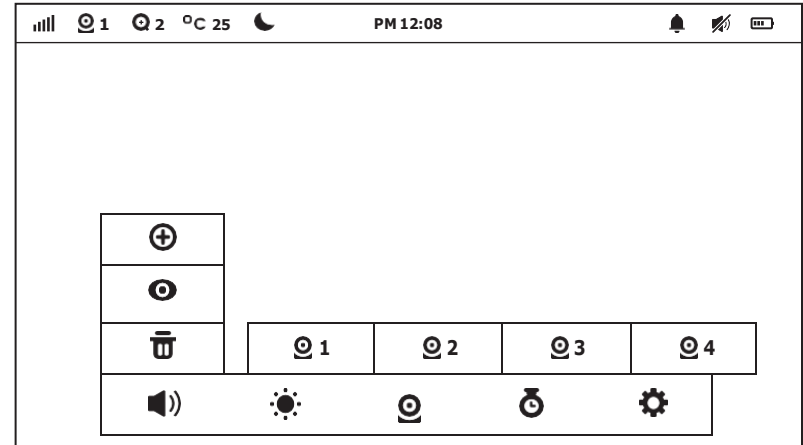











Monitor Interface Overview



Top Status Indications







	Signal	4 levels
	Current Camera	Camera 1 / Camera 2 / Camera 3/ Camera 4
	Zoom	2X / 4X
	Current Temperature	°C / °F
	Night Vision	Auto ON in a dim environment
	Current Time	AM / PM
	Alarm	ON / OFF
	Mute	Mute all system sounds
	Talk-back	ON / OFF
	Battery	5 levels

Bottom Menu Brief

	Add Camera	Max. 4 cameras
	View Camera	Select to view each at a time
	Delete Camera	Select to delete cameras
	Speaker Volume	0-6 levels (mute when it's 0)
	Brightness	1-8 levels
	Camera	To add / view / delete cameras
	Alarm	OFF / 2Hr / 4Hr / 6Hr / Set Time (hour / minute / AM, PM)
	Settings	<ul style="list-style-type: none">  Time  System sound volume  Temperature scale  Auto-sleep time  Restore to factory setting  Customer service contacts

1. Monitor Settings







Press Menu Button, Left and Right Buttons, and then OK Button to set the monitor:

- 1)  **Time setting:** Set the current time by setting hour, minute, and AM/ PM.
- 2)  **System sound volume:** Select between Low, High, and Mute.
- 3)  **Temperature scale:** Select between °C and °F.
- 4)  **Screen auto-sleep time:** Select between 1min, 2min, 5min, and OFF.
- 5)  **Restore to factory settings:** Press OK Button to confirm resetting; "Restoring factory settings" will be shown when restoring, and you can't press any button to control the device during this period. The monitor will auto restart when it's done.
- 6)  **Customer service contacts:** Check the email, Tel. number, and address for customer service.



- To mute the sound during poor monitor-camera connection, please set the  system sound volume to mute.
- When the monitor screen is under sleep mode, the power indicator flashes green slowly while the audio is still on; press any button to awake. You can also short press the Power Button to turn the screen off.
- Press and hold the Power Button to power on / off the monitor.

2. Add / View / Delete a Camera

- 1) Press Menu button, select through  ->  -> **+** to add a camera.
- 2) Select through  ->  to view a camera.
- 3) Select through  ->  to delete a camera.



You can switch viewing different cameras; the current camera number will be shown with the Camera icon  on the monitor. You can only select one camera to view at one time.

3. Digital Zoom & Circulating

Press Zoom Button to zoom in to 2X / 4X when viewing the camera. A third pressing of the button will restore to the original image. Press and hold OK Button 4 seconds to start auto circulating, press OK again to stop.



The current zoom level number will be shown with the Zoom icon  **2** on the monitor

4. Pan-n-Tilt

When viewing the camera, press Left / Right / Up / Down Button to view at different angles, 108 degrees vertically and 270 degrees horizontally.

5. Volume Adjustment

Press Menu Button -> OK Button -> Left / Right Button to volume down / up, and OK Button to saving your settings.



For system sound adjustment, please go to Monitor Settings -> System sound volume .

6. Night Vision

The night vision is automatically activated in a dim environment. The camera has 12 high-intensity infrared LEDs for picking up clear images in the dark. Black and white images can be captured within 2m distance.

7. Alarm

Press Menu Button -> Right Button to locate Alarm menu -> OK Button -> Up / Down Button to select the timer setting. You can set a 2Hr, 4Hr or 6Hr alarm, or set the hour and minute otherwise. When the alarm time is reached, a beep will be heard. Press OK Button to stop; otherwise it'll keep beeping for 30s, beeping again in 1min, stops after it's alerted 3 times.



- When the timer is set, the Alarm icon  will be shown on the monitor.
- Before setting, please check that the monitor time is your current time.

8. Talkback

Press and hold Talk Button to talk to your baby, release it to exit the talking mode.





When you enter the talking mode, the icon  will be shown on the monitor.
When it's mute or the speaker volume is too low, you may not be able to hear the baby.
When you're pressing the Talk Button, the camera will not transfer the sound to the monitor. Please release the button to listen to your baby.

9. Wide-angle Viewing (Optional)

Install your wide-angle lens (separately sold) referring to the previous mounting wide-angle lens section. Now you can view the camera in a wider angle of about 170 degrees.

10. Temperature Alert

The monitor will prompt too high (>35°C/95°F) and too low (<0°C/32°F) temperatures with the "HH" and "LL" icon, accompanied with a  &  icon and a beep alert.



When the monitor is mute, you may not be able to hear the baby.

SPECIFICATIONS

Monitor

Model	VA-IH006PU
Sonix IC	SN93700
Resolution	IPS (720 x 1280), PPI=293
Connectivity	2.4GHz
Image Aspect	16:9 (HD720)
Image Compression	h.264 (frame rate = 18fs)
Operating Range	280 - 300m (antenna vertically positioned at 90°)
Temperature Alert	Yes
Volume Control	8 levels
Brightness	8 levels
Antenna	Rotatable (max. 90 degree)
Power Input	5V / 2A (1.5m long USB C cable)
Zoom	Zoom In (2X) Zoom In (4X) Auto-Pilot (1 Cycle)
Two-Way Talk	Yes
Multi-Camera	Max. 4 cameras
Storage Temperature	-10°C ~ 55°C / 14 - 131°F
Operation Temperature	0°C ~ 40°C / 32 - 104 °F

Camera

Model	VA-IH006BU
Cmos	720p (1280x720), 3.0M, 1/4"
Connectivity	2.4GHz
Image Compression	h.264 (frame rate = 18fs)
Power Input	5V / 1.2A, 2.5m-long Micro-USB cable
Pan-n-Tilt	108 degrees vertical (Up=90, Down=18) 270 degrees horizontal (Left=135, Right=135)
Zoom	Zoom In (2X) Zoom In (4X) Auto-Pilot (1 Cycle)
View Angle	Vertical: 1.5m, Horizontal: 1.4m
Lens Focal Length	1.5m to infinity
Night Vision	Black & White image, up to 2m clear range
IR LED	Non-visible IR LED with wavelength 940nm (x 12 pcs)
Light Sensor	Yes
Two-Way Talk	Yes
Storage Temperature	-10°C ~ 55°C / 14 - 131°F

TROUBLESHOOTING

Product not powering on?	<ul style="list-style-type: none"> · Check that the camera and monitor are turned on. · Check the camera is connected to power properly (it cannot be charged; it's power off once disconnected from power). · Check that the monitor is of enough battery (it'll auto shut off when battery level icon flashes red slowly on the monitor).
Baby monitor can't connect with the camera?	<ul style="list-style-type: none"> · Check whether the camera is near the monitor (recommended to keep within 1.5-2m / 4.9-6.6ft). · Check whether the monitor is of low battery. Charge it in time to restore good connection. · Check whether the camera is well connected to power. · Check whether there are any large metallic objects including doors, refrigerators, mirrors, etc., are placed between the camera and monitor thus blocking the radio signals. · Check whether there's any other 2.4GHz product is used nearby like WiFi routers, microwave ovens, which may interfere the connection. · If nothing above is involved, please retry to pair: Press and hold the OK button on monitor to enter pairing mode, and the monitor will connect with the camera nearby automatically.
Nothing shown when I view a camera?	<ul style="list-style-type: none"> · Check all connections to the camera (power cable plugging and pairing). · Check whether the screen is in sleep mode. Press any button to awake it. · Check whether the camera is within range of the monitor. · Adjust the monitor antenna to vertical position for better signal transfer.

No sound from the monitor?	Check whether the system sound volume is set High or Low. It'll be mute if set so.
Black and white pictures?	Night vision LED may be ON. Please turn on room lights to force it out of the night mode.
Choppy videos?	<ul style="list-style-type: none"> · Check whether the camera is near the monitor and that there're no obstacles between them. · Adjust the monitor antenna to vertical position for better signal transfer.
Too much noise?	<ul style="list-style-type: none"> · Volume may be set too high. Press Menu Button -> OK Button -> Left Button to volume down. · The camera and monitor may be put too close; keep them at least 1.5m / 4.9ft apart. · The camera may be too out of range. Please keep it within 10m / 32.8ft to the monitor.

WARRANTY & CUSTOMER SERVICE

18 months warranty

Lifetime customer service (contacts on the monitor, and back cover of this User Guide)

FCC STATEMENT

changes or modifications not expressly approved by the party responsible for compliance could void the user's authority to operate the equipment.

This device complies with Part 15 of the FCC Rules. Operation is subject to the following two conditions:

- (1) this device may not cause harmful interference, and
- (2) this device must accept any interference received, including interference that may cause undesired operation.

Note: This equipment has been tested and found to comply with the limits for a Class B digital device, pursuant to Part 15 of the FCC Rules. These limits are designed to provide reasonable protection against harmful interference in a residential installation. This equipment generates, uses, and can radiate radio frequency energy, and if not installed and used in accordance with the instructions, may cause harmful interference to radio communications. However, there is no guarantee that interference will not occur in a particular installation. If this equipment does cause harmful interference to radio or television reception, which can be determined by turning the equipment off and on, the user is encouraged to try to correct the interference by one or more of the following measures:

- Reorient or relocate the receiving antenna.
- Increase the separation between the equipment and receiver.
- Connect the equipment into an outlet on a circuit different from that to which the receiver is connected.
- Consult the dealer or an experienced radio/TV technician for help.

15.21& SAR statements

This equipment complies with FCC radiation exposure limits set forth for an uncontrolled environment. End user must follow the specific operating instructions for satisfying RF exposure compliance. This transmitter must not be co-located or operating in conjunction with any other antenna or transmitter.

The mobile device is designed to meet the requirements for exposure to radio waves established by the Federal Communications Commission (USA). These requirements set a SAR limit of 1.6 W/kg averaged over one gram of tissue. The highest SAR value reported under

this standard during product certification for use when properly worn on the body is 0.515 W/kg.

For body operation, this device has been tested and meets FCC RF exposure guidelines when used with any accessory that contains no metal and that positions a minimum of 15mm from the body. Use of other accessories may not ensure compliance with FCC RF exposure guidelines.

FCC 20cm Statement

This equipment complies with FCC radiation exposure limits set forth for an uncontrolled environment. This equipment should be installed and operated with a minimum distance of 20cm between the radiator & your body. This transmitter must not be co-located or operating in conjunction with any other antenna or transmitter.

IC STATEMENT

This device contains licence-exempt transmitter(s)/receiver(s) that comply with Innovation, Science and Economic Development Canada's licence-exempt RSS(s). Operation is subject to the following two conditions:

- (1) This device may not cause interference.
- (2) This device must accept any interference, including interference that may cause undesired operation of the device.

L'émetteur/récepteur exempt de licence contenu dans le présent appareil est conforme aux CNR d'Innovation, Sciences et Développement économique Canada applicables aux appareils radio exempts de licence. L'exploitation est autorisée aux deux conditions suivantes :

- 1) L'appareil ne doit pas produire de brouillage;
- 2) L'appareil doit accepter tout brouillage radioélectrique subi, même si le brouillage est susceptible d'en compromettre le fonctionnement.

The device meets the exemption from the routine evaluation limits in section 2.5 of RSS 102 and compliance with RSS-102 RF exposure, users can obtain Canadian information on RF exposure and compliance.

Le dispositif rencontre l'exemption des limites courantes d'évaluation dans la section 2.5 de RSS 102 et la conformité à l'exposition de RSS-102 rf, utilisateurs peut obtenir l'information canadienne sur l'exposition et la conformité de rf.

This transmitter must not be co-located or operating in conjunction with any other antenna or transmitter. This equipment should be installed and operated with a minimum distance of 20 centimeters between the radiator and your body.

Cet émetteur ne doit pas être Co-placé ou ne fonctionnant en même temps qu'aucune autre antenne ou émetteur. Cet équipement devrait être installé et actionné avec une distance minimum de 20 centimètres entre le radiateur et votre corps.

尺寸：120*160mm
装订成册

材质：封面128克铜版纸 内页80克书纸