



RAZER LEVIATHAN V2

MASTER GUIDE

Amp up your setup in every way imaginable with the **Razer Leviathan V2**—a multi-driver gaming soundbar and subwoofer featuring THX® Spatial Audio and Razer Chroma™ RGB. Experience unrivalled immersion in both sight and sound, backed by low-latency Bluetooth 5.2 for seamless PC and mobile use.

CONTENTS

1. WHAT'S INSIDE / WHAT'S NEEDED	3
2. LET'S GET YOU COVERED	6
3. TECHNICAL SPECIFICATIONS	7
4. GETTING STARTED.....	8
5. USING THE SOUNDBAR	13
6. CONFIGURING YOUR RAZER LEVIATHAN V2 VIA RAZER SYNAPSE	17
7. SAFETY AND MAINTENANCE	27
8. LEGALESE.....	28

1. WHAT'S INSIDE / WHAT'S NEEDED

WHAT'S INSIDE

- Razer Leviathan V2

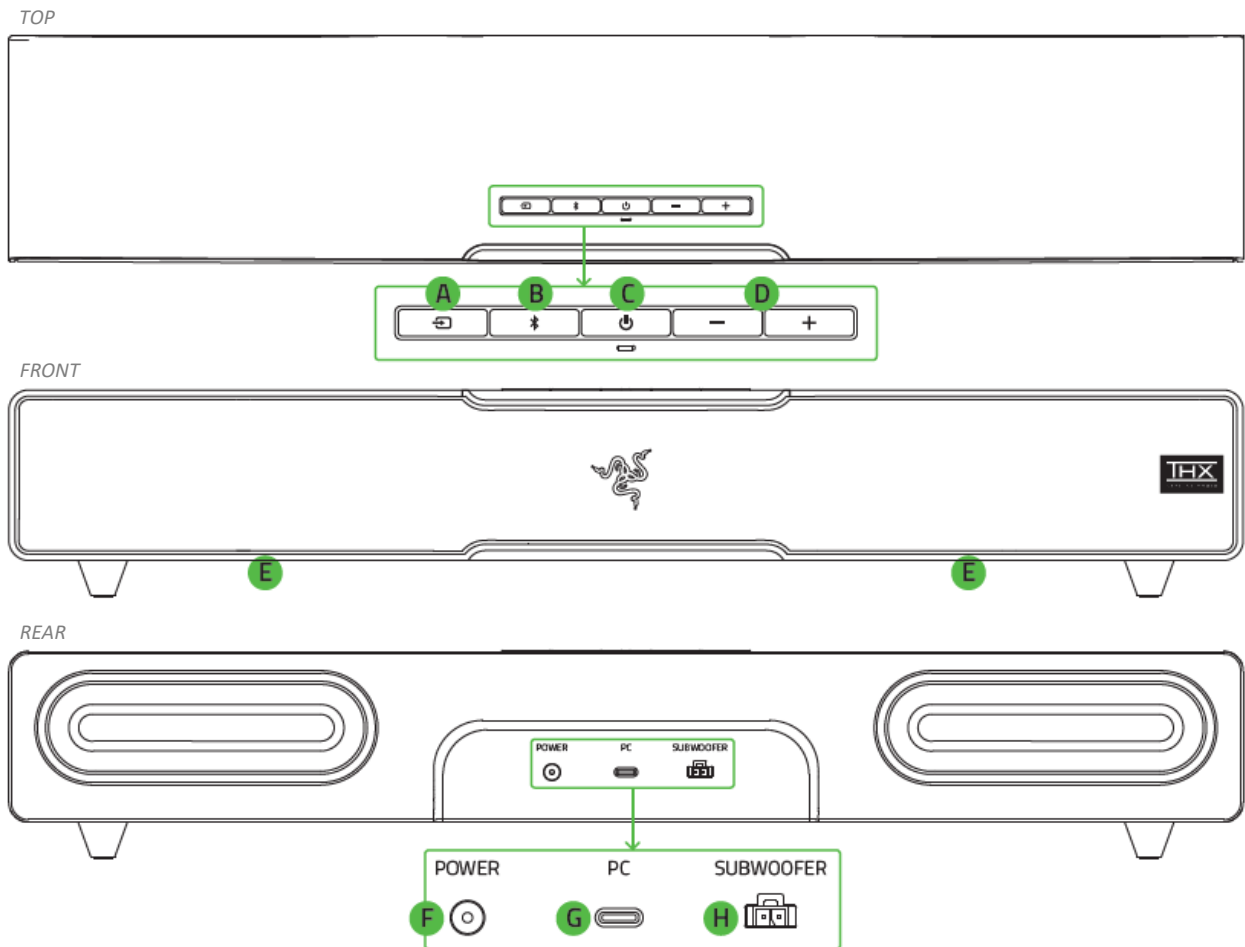

- A. Source button
- B. Bluetooth button
- C. Power button
- D. Volume control buttons
- E. Soundbar lighting Powered by Razer Chroma™ RGB
- F. Power port
- G. Type-C port
- H. Subwoofer output port

- Subwoofer

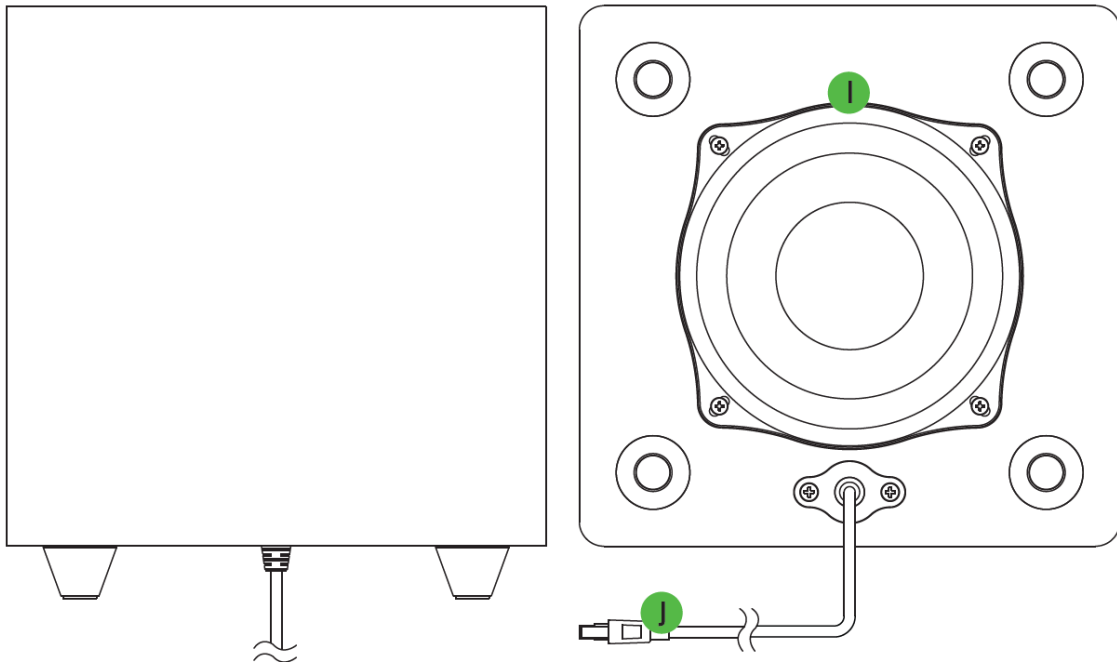

- I. Rear facing bass port
- J. Subwoofer connector

- Type-C to Type-A cable

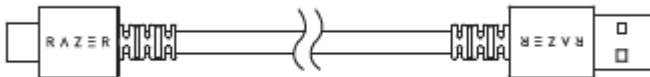

- Detachable feet for soundbar angle adjustment



Flat-feet (pre-installed)



Raised-feet

- Power adapter + regional power cord

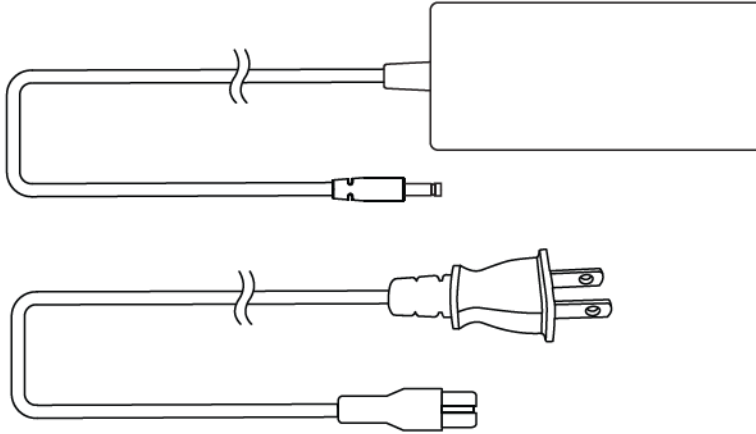

- Important Product Information Guide

WHAT'S NEEDED

Product requirements

- USB-A port
- OR
- Devices with Bluetooth 5.0 connectivity

Razer Synapse requirements

- Windows® 10 64-bit (or higher)
- Internet connection for software installation

Razer Audio / Razer Chroma RGB app requirements

- iOS 12 / Android 8.1 Oreo (or higher) device with Bluetooth 5.0 connectivity
- Internet connection for app installation

2. LET'S GET YOU COVERED

You've got a great device in your hands, complete with a 2-year limited warranty coverage. Now maximize its potential and score exclusive Razer benefits by registering at razerid.razer.com



Got a question? Ask the Razer Support Team at support.razer.com

3. TECHNICAL SPECIFICATIONS

- Razer Chroma™ RGB (18 zones)
- THX® Spatial Audio (PC based via Razer Synapse)
- Bluetooth 5.2 (60 ms low latency)
- USB audio input
- Wired subwoofer
- Razer Audio app
- Razer Chroma RGB app
- Custom 10-band EQ
- Raised feet on soundbar
- 500 mm length to sit beneath monitor
- Headphone quick toggle
- Frequency Response: 45 Hz – 20 kHz
- Input Power: External 65 W power adapter
- Power: 65 W
- Driver Size – Diameters (mm)
 - Full Range Drivers: 2 x 2.0 x 4.0" / 48 x 95 mm
 - Tweeter Drivers: 2 x 0.75" / 20 mm
 - Passive Radiator Drivers: 2 x 1.7 x 5.3" / 43 x 135 mm
 - Down-Firing Subwoofer: 1 x 5.5" / 140 mm
 - Driver Type: Full range drivers, tweeters drivers, passive radiator, and subwoofer driver
- Weight
 - Soundbar: 3.08 lbs / 1.4 kg
 - Subwoofer: 6.61 lbs / 3.0 kg
- Dimensions
 - Soundbar: 19.7 x 3.6 x 3.3" / 500 x 91.3 x 84 mm
 - Subwoofer: 8.67 x 8.67 x 9.5" / 220 x 220 x 241.5 mm
- Compatibility
 - Bluetooth connection
 - USB connection to PC

4. GETTING STARTED

SETTING IT UP

1. Position the soundbar and subwoofer on a flat and stable surface as required in your setup.

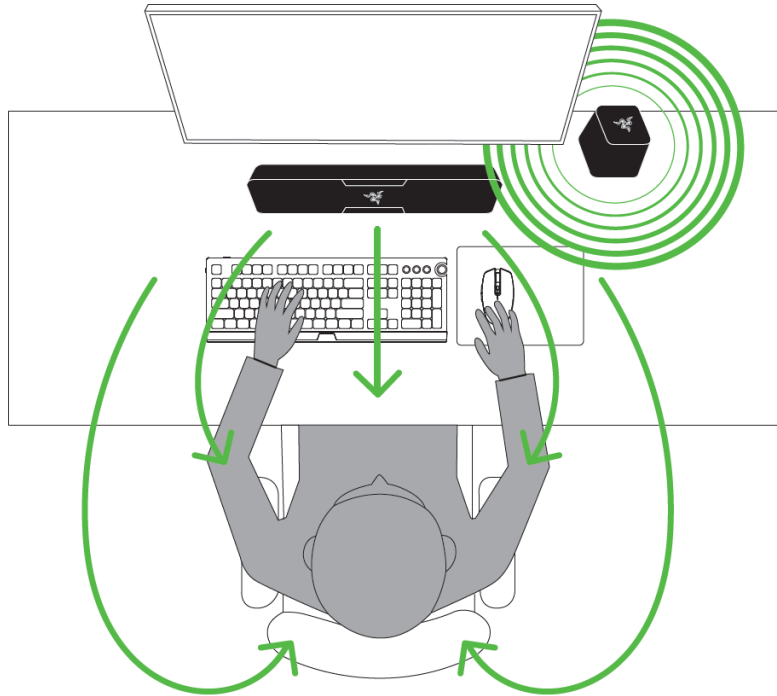

- i** *It's recommended to place the subwoofer on the floor regardless of the positioning of the soundbar.*

2. Connect the subwoofer to the subwoofer output port on the soundbar.

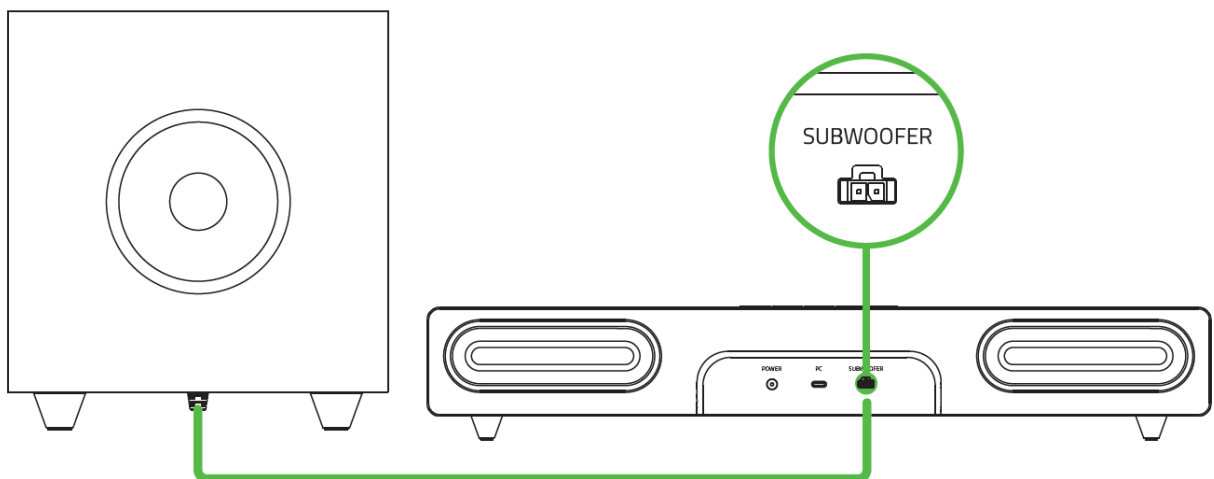

- i** *Make sure to press down on the connector catch clip before plugging/unplugging the subwoofer connector.*

3. With the appropriate power cord connected to the power adapter, insert its AC plug into a power outlet, and then connect it to the power port of the Razer Leviathan V2.

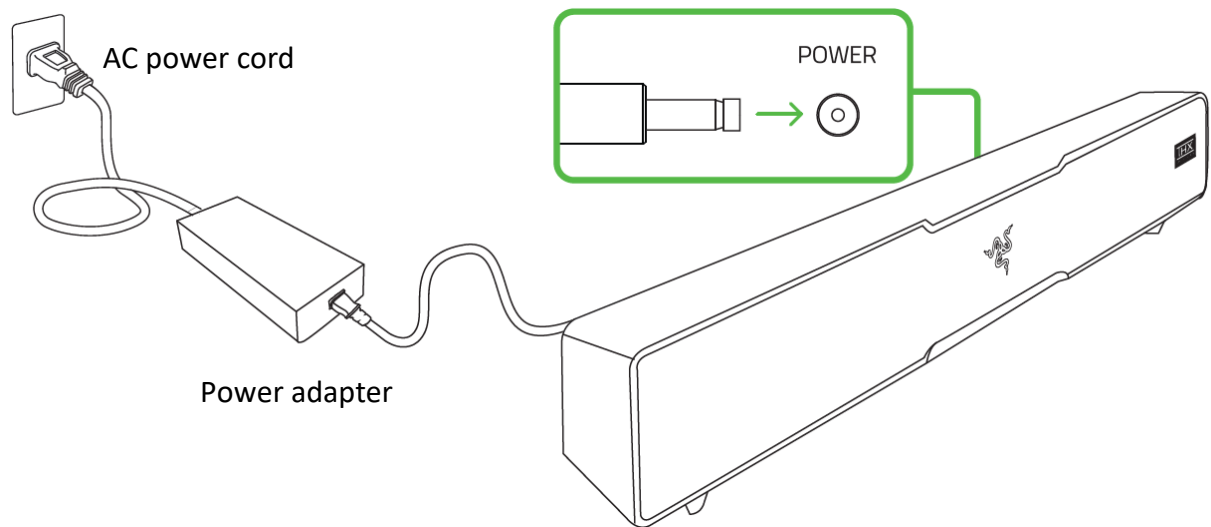

CONNECTING YOUR SOUNDBAR

To a PC via PC mode

1. Connect the soundbar to any of the USB-A ports on your PC using the included Type-C to Type-A cable.

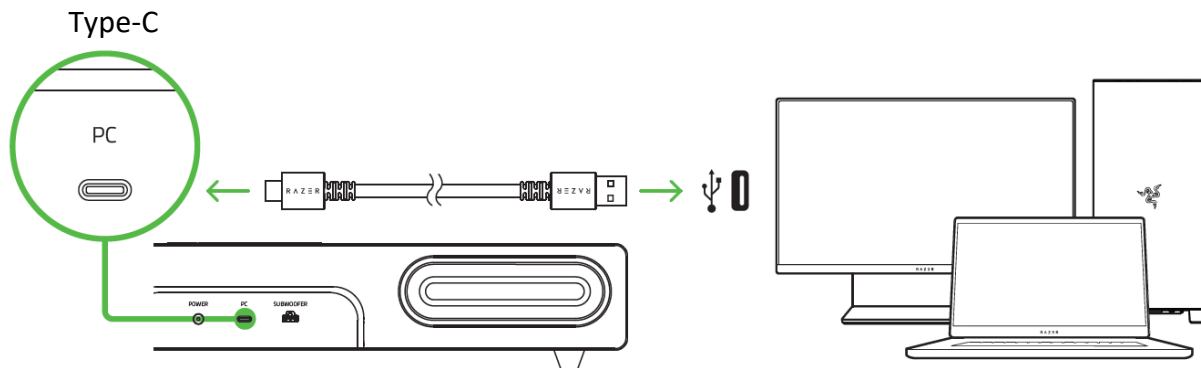

2. Press the Power button to turn on the soundbar. The Power button and Source button will light up in green to show that the soundbar is on and in PC mode.

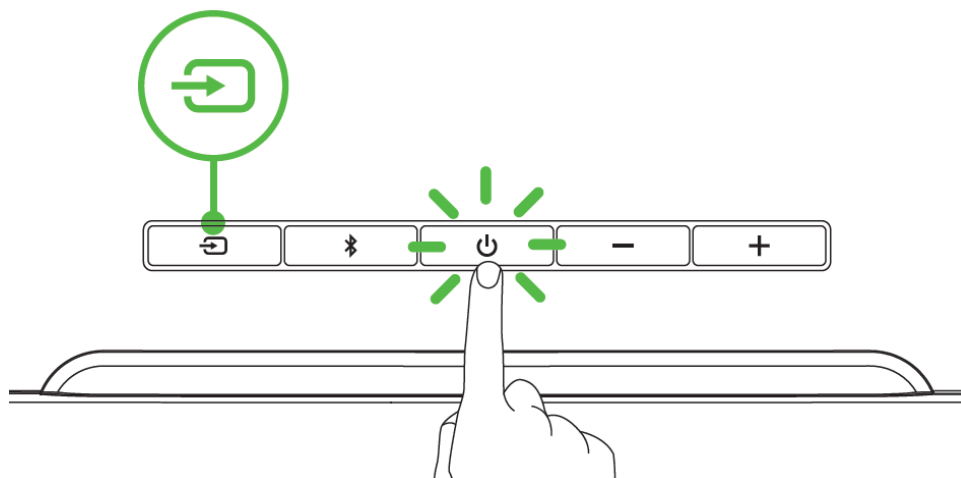

3. On your PC, right-click on the sound icon on the system tray, and then select **Open Sound settings**.

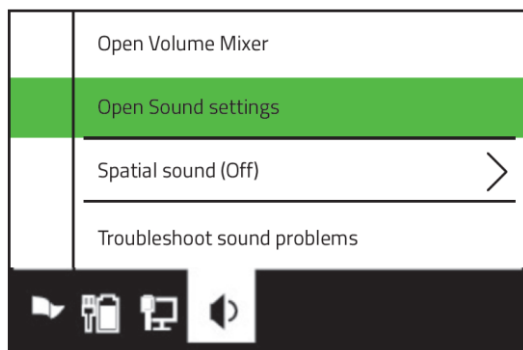

4. On the **Sound** window, set **Razer Leviathan V2** as the default **Output** device.

Sound

Output

Choose your output device

Razer Leviathan V2

The Razer Leviathan V2 is now ready for use in PC mode.

To other devices via Bluetooth mode

1. Press the Power button to turn on the soundbar. The Power button will light up to show that the soundbar is on.

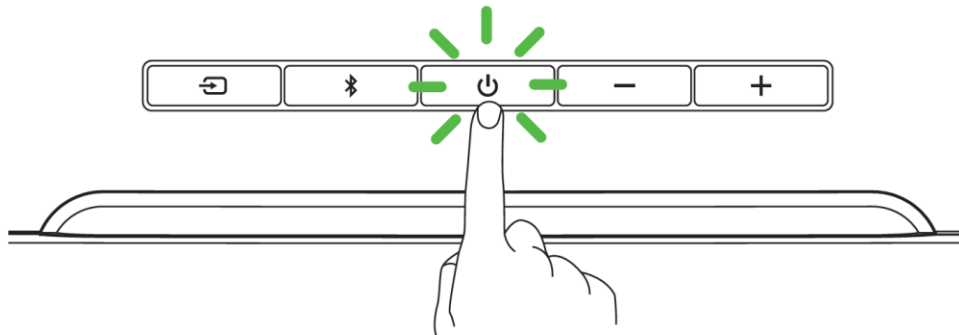

2. Press the Bluetooth button to switch to Bluetooth mode. The Source button will blink in blue to indicate that the soundbar is in pairing mode.

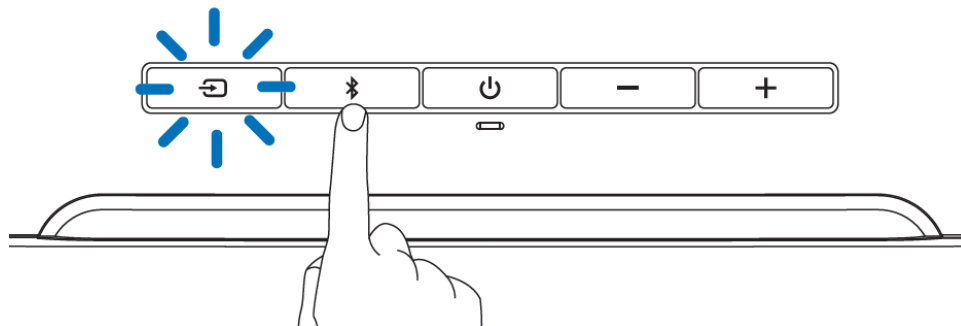

3. Activate Bluetooth on your device and select **Razer Leviathan V2** from the list of devices found.
4. Wait until both devices are connected. The Source button will change to static blue indicating that the soundbar is now connected to your device.

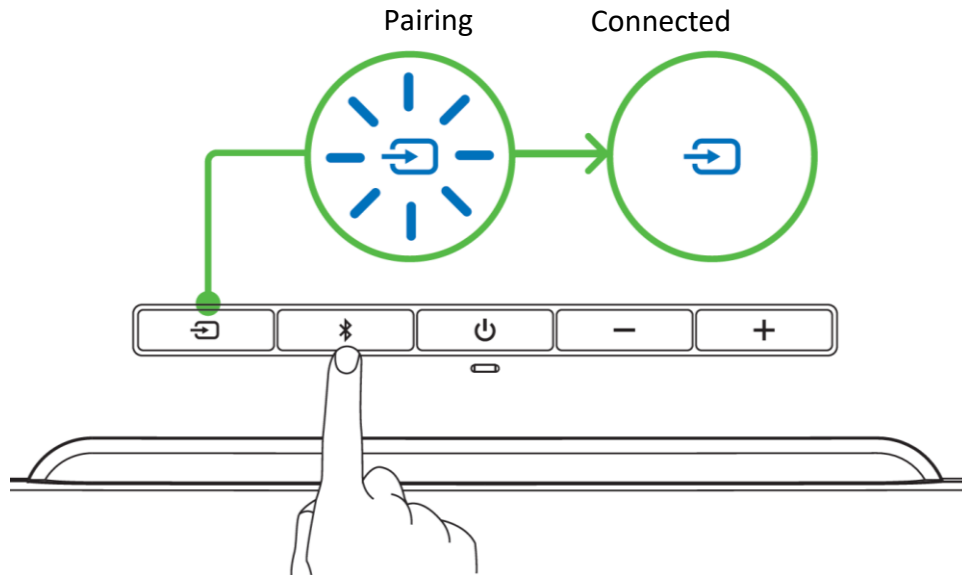

The Razer Leviathan V2 is now ready for use in Bluetooth mode.

ACTIVATE THX® SPATIAL AUDIO*

Unleash the full potential of the Razer Leviathan V2 by enabling 360° positional audio for a natural and lifelike experience through Razer Synapse.



**Only available on Windows 10 and above.*

5. USING THE SOUNDBAR

POWER BUTTON

Press the Power button to turn on or off the soundbar. The Power button will light up to show that the soundbar is on.

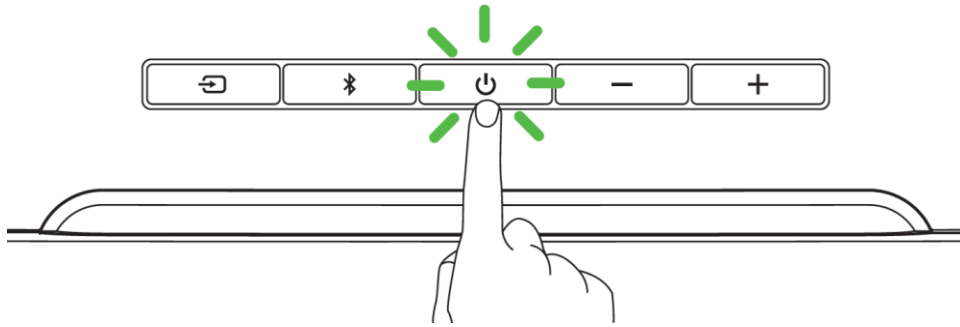

SOURCE BUTTON

While powered on, press the Source button to switch between PC mode and Bluetooth mode.

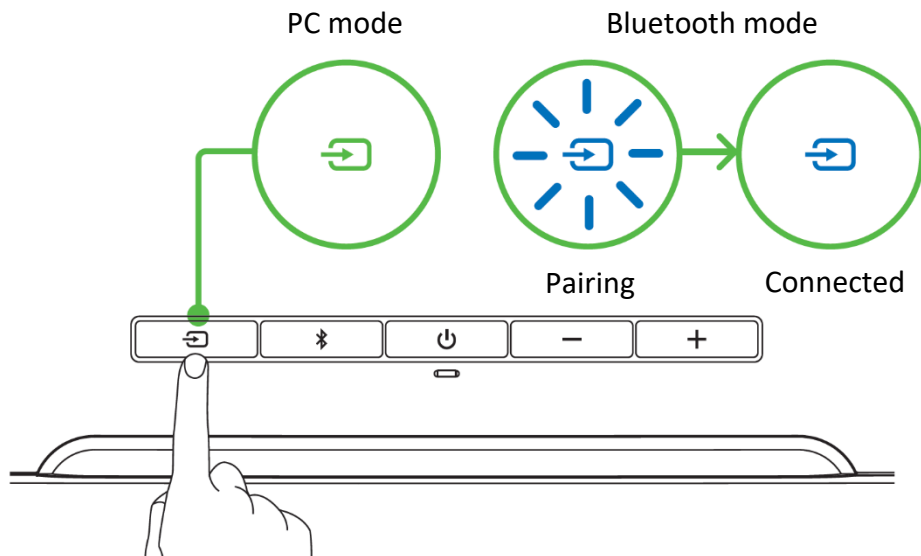

i When switching to Bluetooth mode, solid blue will be shown when the soundbar reconnects to the last known device; pairing mode will be activated there are no devices found.

BLUETOOTH BUTTON

Switch to Bluetooth Mode

While powered on and in PC mode, press the Bluetooth button to switch to Bluetooth mode and reconnect the soundbar to the last known device. The Source button will light up in static blue to indicate that the soundbar is now connected to your device.

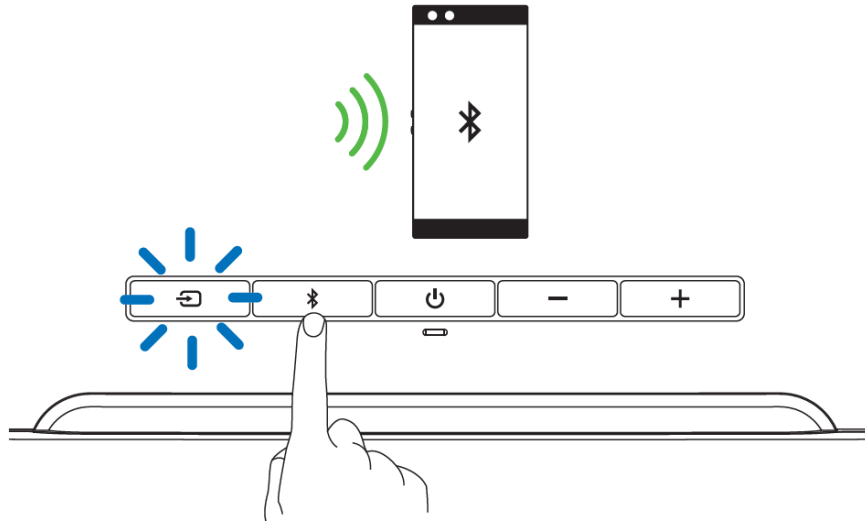

i The soundbar will activate pairing mode when no device is found.

Activate pairing mode

Activate pairing mode if you want to pair the soundbar to a different device. While powered on and in Bluetooth mode, press the Bluetooth button for 6 seconds to activate pairing mode. A distinct tone will help notify you that the soundbar is now in pairing mode. Follow your device's instructions and select "**Razer Leviathan V2**" from the list of found devices. The Source button will briefly change to static blue to indicate that the soundbar is now connected to your device.

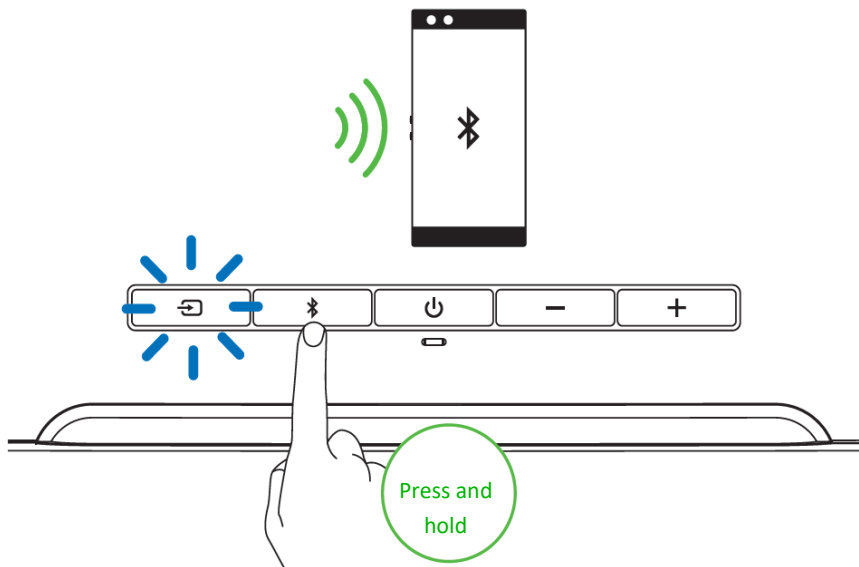

VOLUME CONTROL BUTTONS

Press the volume control buttons to increase or decrease the volume of the current source mode.

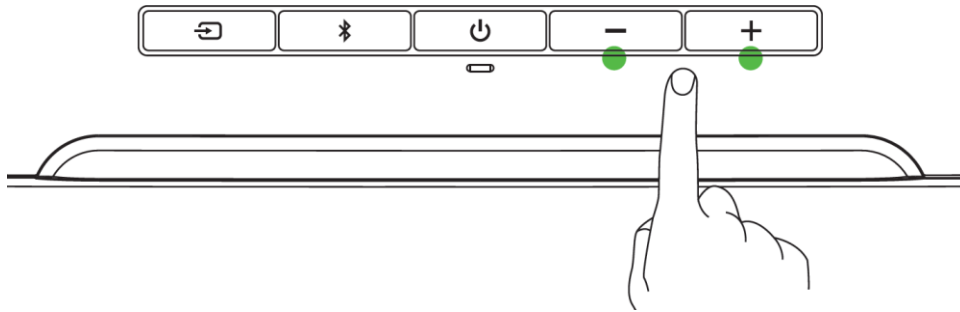

SOUNDBAR FEET

The extra pair of detachable feet lets you change the soundbar angle to ensure that sound is delivered with the least amount of obstruction. Depending on the feet orientation, you can set the soundbar to either a flat or raised angle.

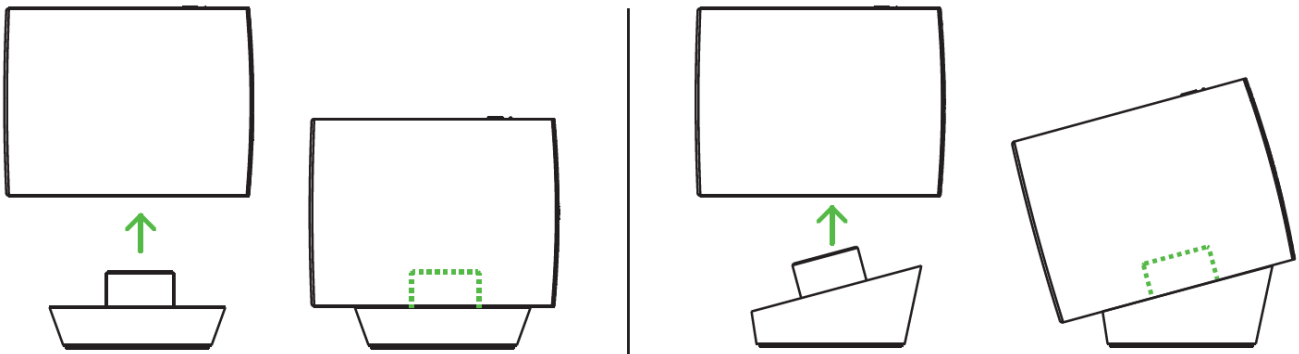

PERSONALIZE YOUR EXPERIENCE

Razer Synapse (PC)

Use the Razer Synapse* app to select from any of the soundbar's EQ presets or customize your own, and even personalize and sync its lighting effect across all other Razer Synapse-enabled devices for an immersive lighting experience that's truly yours.

**Only available in PC mode. Install Razer Synapse when prompted or download the installer from razer.com/synapse.*

Razer Audio app (mobile)

Making advanced customization just got a whole lot easier for the Razer Leviathan V2. With the Razer Audio App, you'll be able to mute or adjust its volume, customize its EQ settings and auto shutoff feature, and much more.

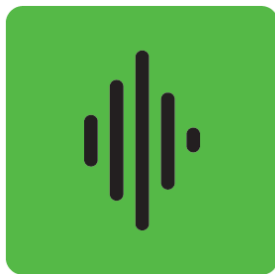

Razer Audio



Razer Chroma RGB app (mobile)

With 16.8 million colors and a suite of effects to choose from, use the Razer Chroma RGB app to change the lighting effect of the soundbar from your mobile device.



Razer Chroma RGB



6. CONFIGURING YOUR RAZER LEVIATHAN V2 VIA RAZER SYNAPSE

i *Internet connection is required for installation, updates and cloud-based features. Registering for a Razer ID account is recommended, but optional. All listed features are subject to change based on the current software version, connected device(s), and supported apps and software.*

SYNAPSE TAB

The Synapse tab is your default tab when you first launch Razer Synapse. This tab allows you to navigate the Dashboard subtab.

Dashboard

The Dashboard subtab is an overview of your Razer Synapse, where you can access all your Razer devices, modules, and online services.

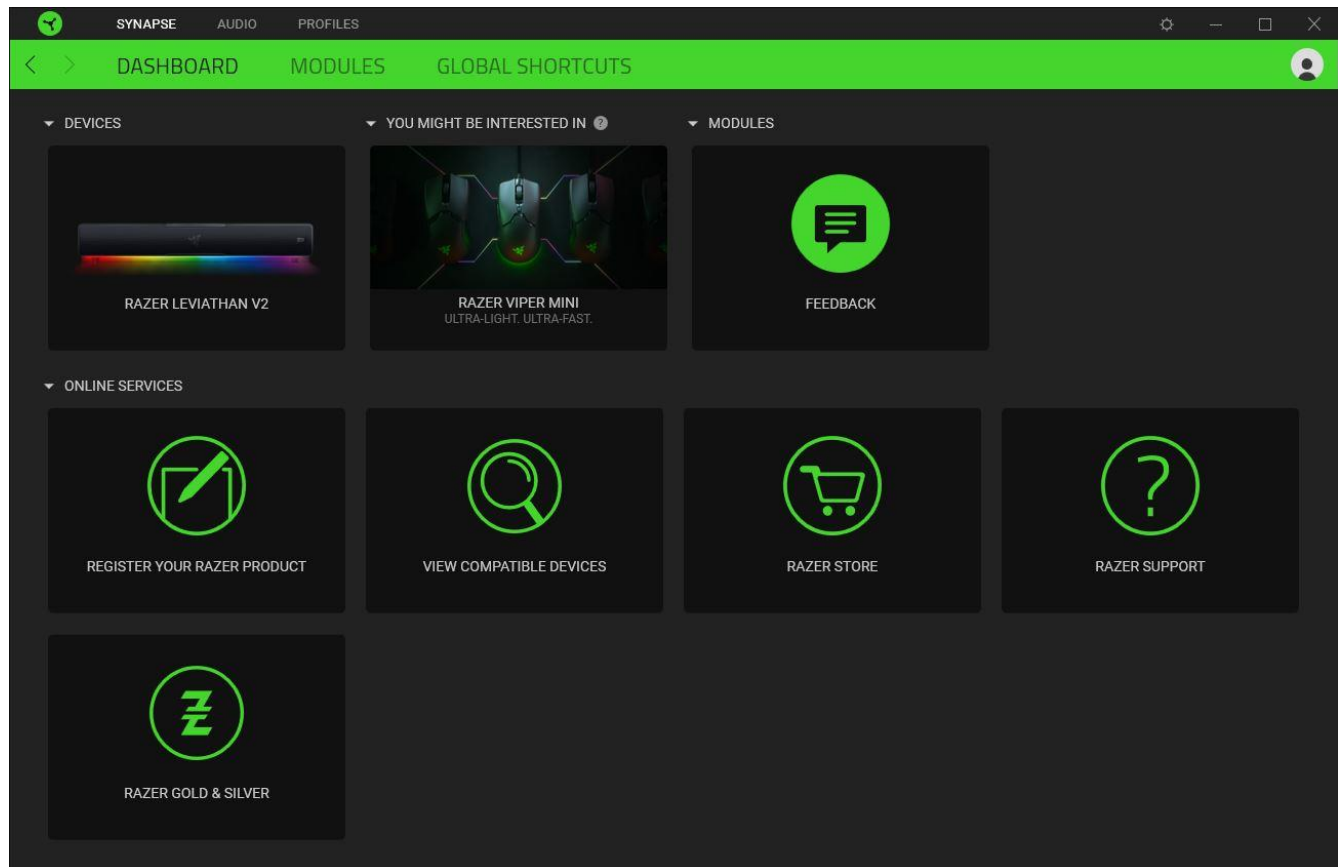

Modules

The Modules subtab displays all installed and available modules for installation.

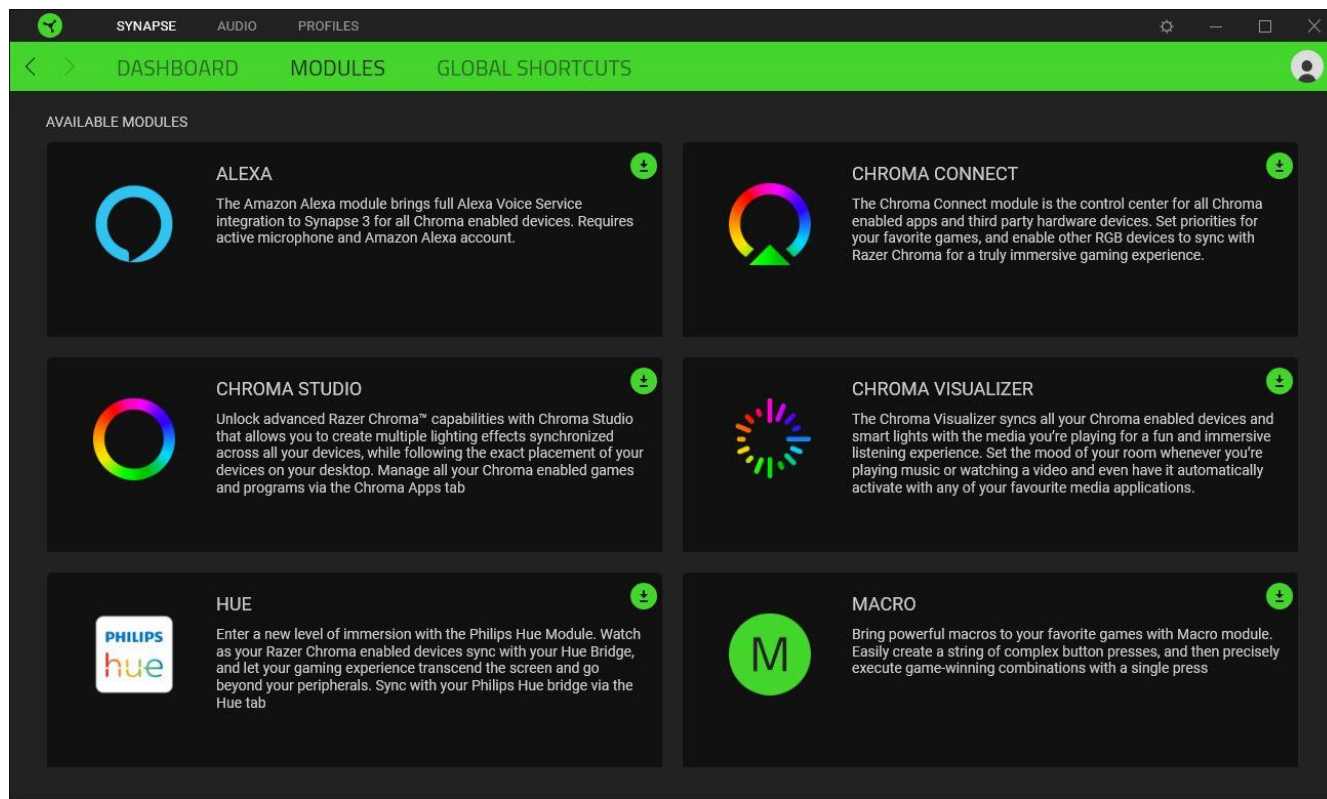

Global Shortcuts

Bind operations or Razer Synapse functions to custom key-combinations from any Razer Synapse-enabled device inputs, which apply across all device profiles. [Learn more about Profiles](#)

! Only Razer Synapse-enabled device inputs will be recognized.

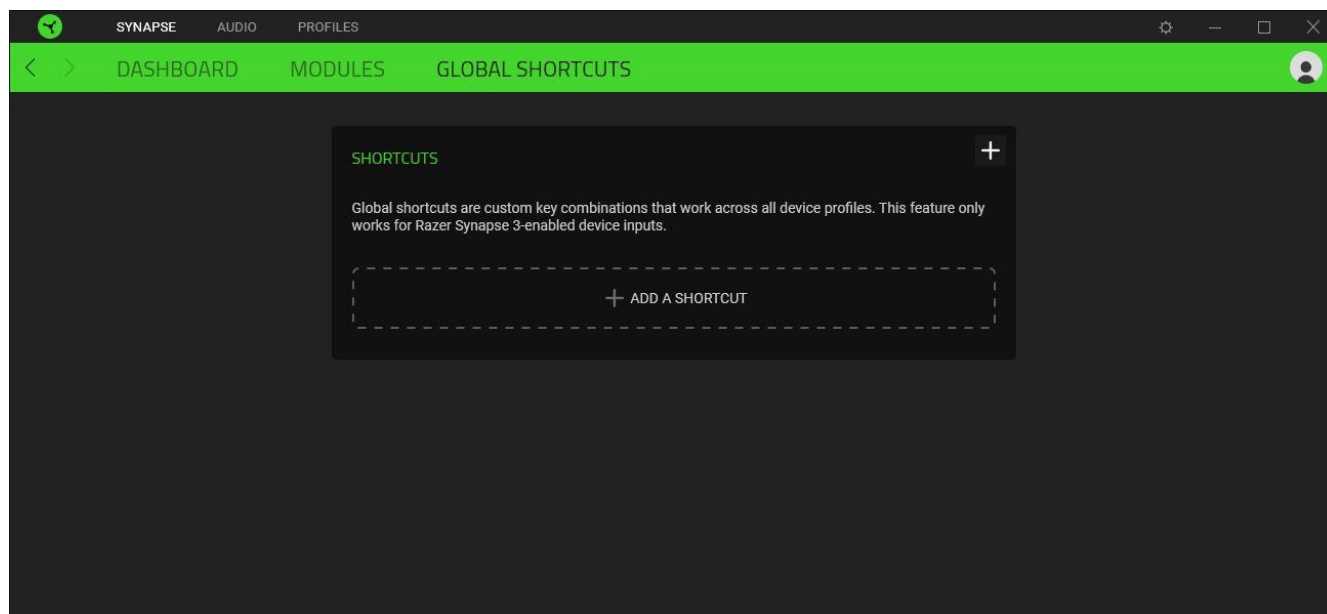

AUDIO TAB

The Audio tab is the main tab for your Razer Leviathan V2. From here, you can customize your soundbar's settings to unleash its full potential. Changes made under this tab are automatically saved to your system and cloud storage.

Sound

The Sound subtab is for toggling between stereo and THX® Spatial audio, setting a secondary playback device, and customizing the incoming audio settings and frequency response of the soundbar.

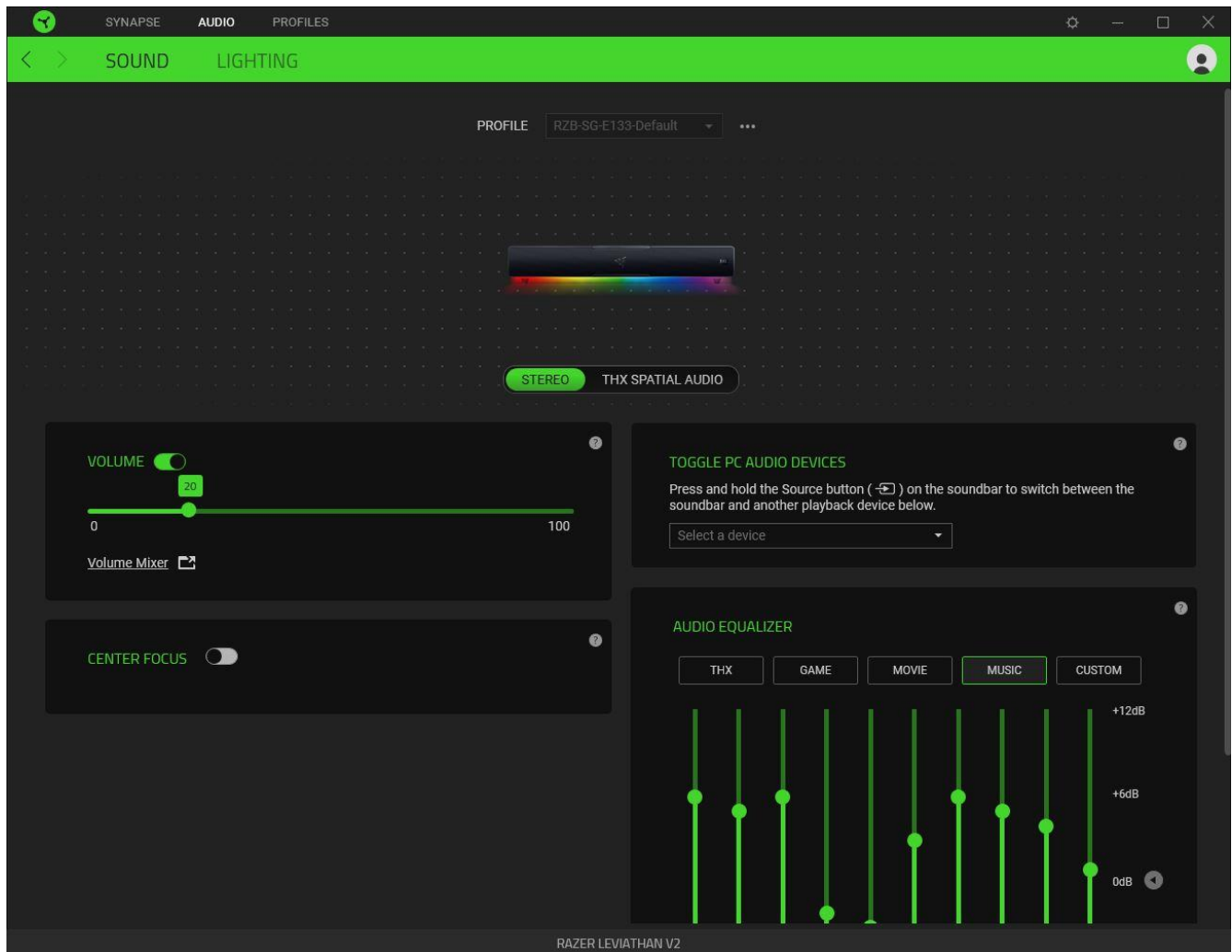

Profile

Profile is a data storage for keeping all your Razer peripheral's settings. By default, the profile name is based on your system's name. To add, rename, duplicate, or delete a profile, simply press the Miscellaneous button (●●●).

Stereo / THX® Spatial Audio

Toggle between stereo audio and THX® Spatial Audio.

Volume

Adjust the audio volume of the soundbar. You may also access the Windows volume mixer of the current playback device, where you can proportionally adjust the overall volume of the system or individually adjust the volume of each active application.

Toggle PC audio devices

Set a secondary playback device that you can immediately switch audio with when you press and hold the Source button on the soundbar.

Center focus

Enable this setting to direct the soundstage towards the user to increase the clarity in the center channel. This feature works best with multi-channel audio content.

Audio equalizer

Select any of the available equalizer presets created for the best audio experience designed for balance, gaming immersion, movie viewing, or enjoying your favorite music. Manually adjusting any equalizer preset will automatically set it to Custom.

Lighting

The Lighting subtab enables you to customize the lighting on the soundbar.

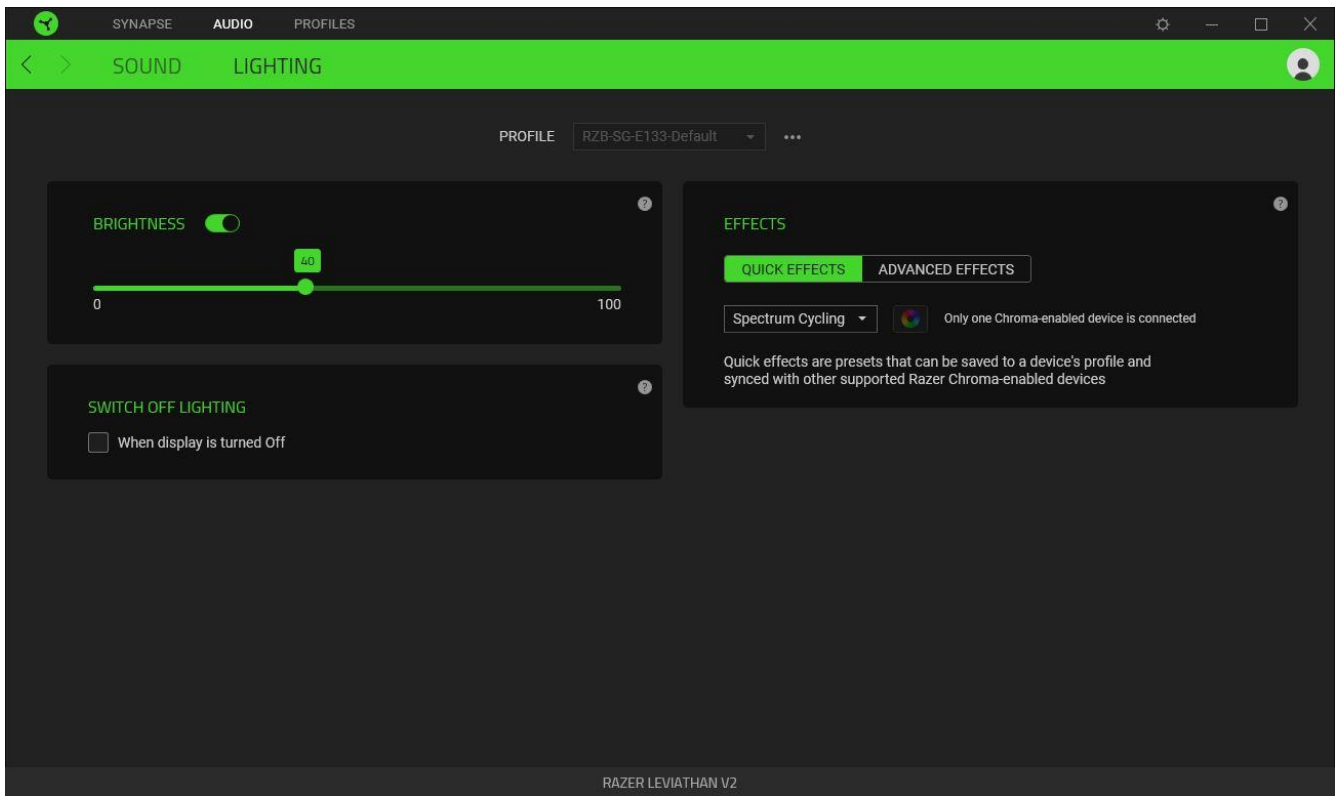

Brightness



You can turn off the soundbar lighting by toggling the Brightness option or increase/decrease the luminance using the slider.



Switch Off Lighting

This power saving tool allows you to disable soundbar lighting when your system's display is turned off.

Quick Effects

A number of quick effects can be selected and applied to your soundbar's lighting, as listed here:

	Name	Description	How to set up
	Breathing	The lighting will fade in and out of the selected color(s)	Select up to 2 colors or randomize colors
	Spectrum cycling	The lighting will cycle between 16.8 million colors indefinitely	No further customization required

	Static	The soundbar will remain lit in the selected color	Select a color
	Wave	The lighting will scroll across the soundbar in the direction selected	Select a wave direction

If you have other supported Razer Chroma-enabled devices, you can synchronize their quick effects with your Razer device by clicking the Chroma Sync button ().

 *Only devices that support the selected lighting effect will synchronize.*

Advanced Effects

The Advanced Effects option allows you to choose a Chroma Effect you want to use on your Razer Chroma-enabled peripheral. To start making your own Chroma Effect, simply press the Chroma Studio button ().



PROFILES TAB

The Profiles tab is a convenient way to manage all your profiles and link them to your games and applications.

Devices

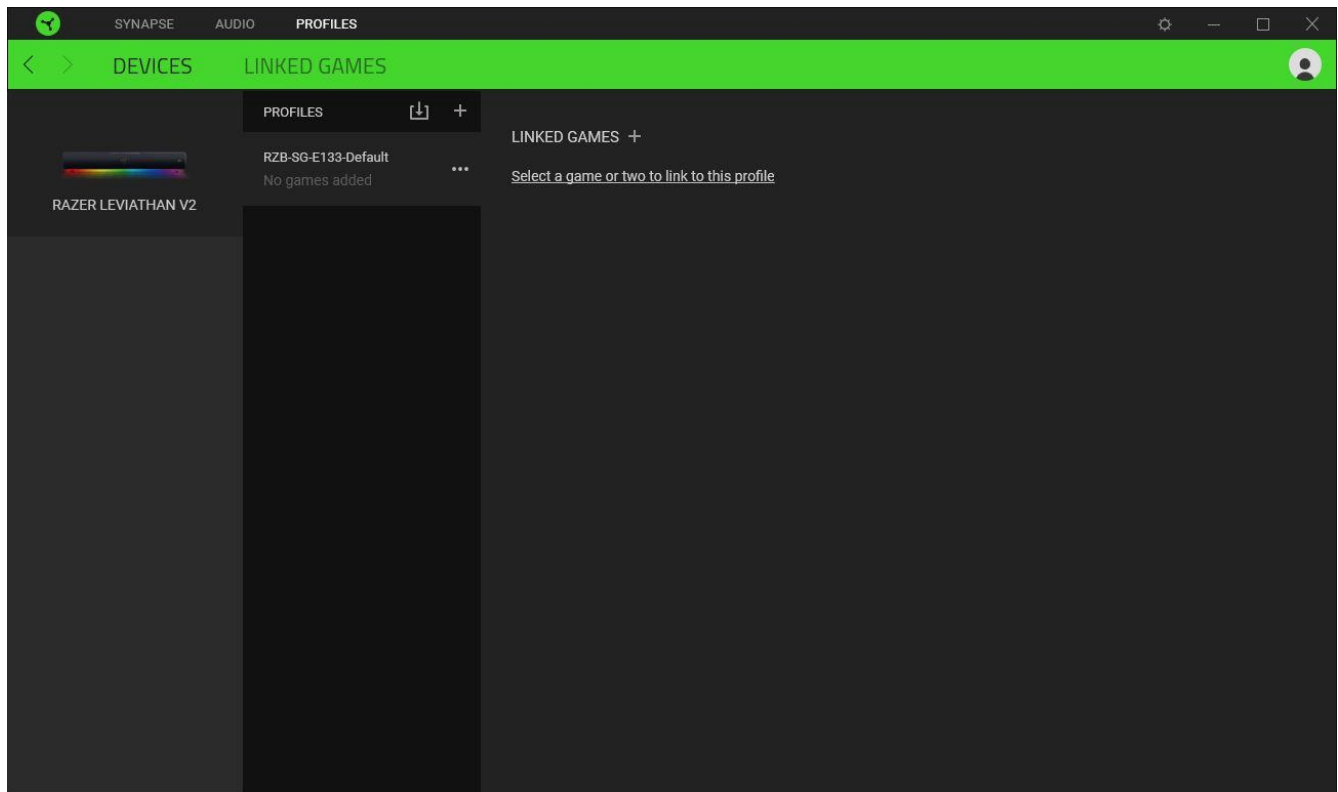
View which games are linked to each device's profiles or which Chroma Effect is linked to specific games using the Devices subtab.



You can import Profiles from your computer or the cloud through the import button () or create new profiles within the selected device using the add button (). To rename, duplicate, export, or delete a profile, simply press the Miscellaneous button (). Each profile can be set to activate when you run an application using the Linked Games option.

Linked Games

The Linked Games subtab allows you to add games, view devices linked to games, or search for added games. You can also sort games based on alphabetical order, last played, or most played. Added games will still be listed here, even if they are not linked to a Razer device.

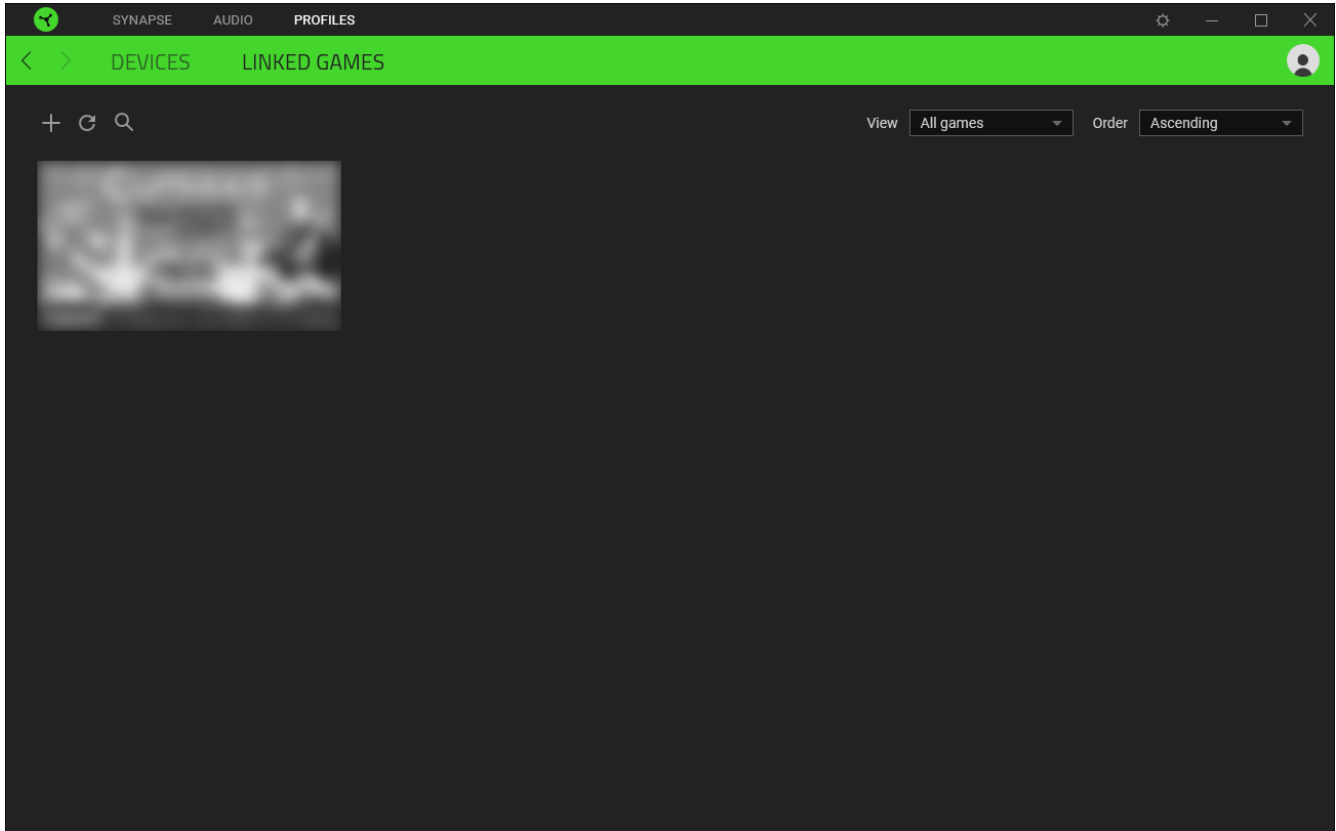

To link games to connected Razer devices or Chroma Effects, simply click on any game from the list, and then click **Select a device and its profile to launch automatically during gameplay** to select the Razer device or Chroma Effect it will link with. Once connected, you may click the Miscellaneous button (●●●) of the corresponding Chroma Effect or device to select a specific Chroma Effect or profile.

SETTINGS WINDOW

The Settings window, accessible by clicking the (⚙) button on Razer Synapse, enables you to configure the startup behavior and display language of Razer Synapse, view the master guides of each connected Razer device or perform a factory reset on any connected Razer device.

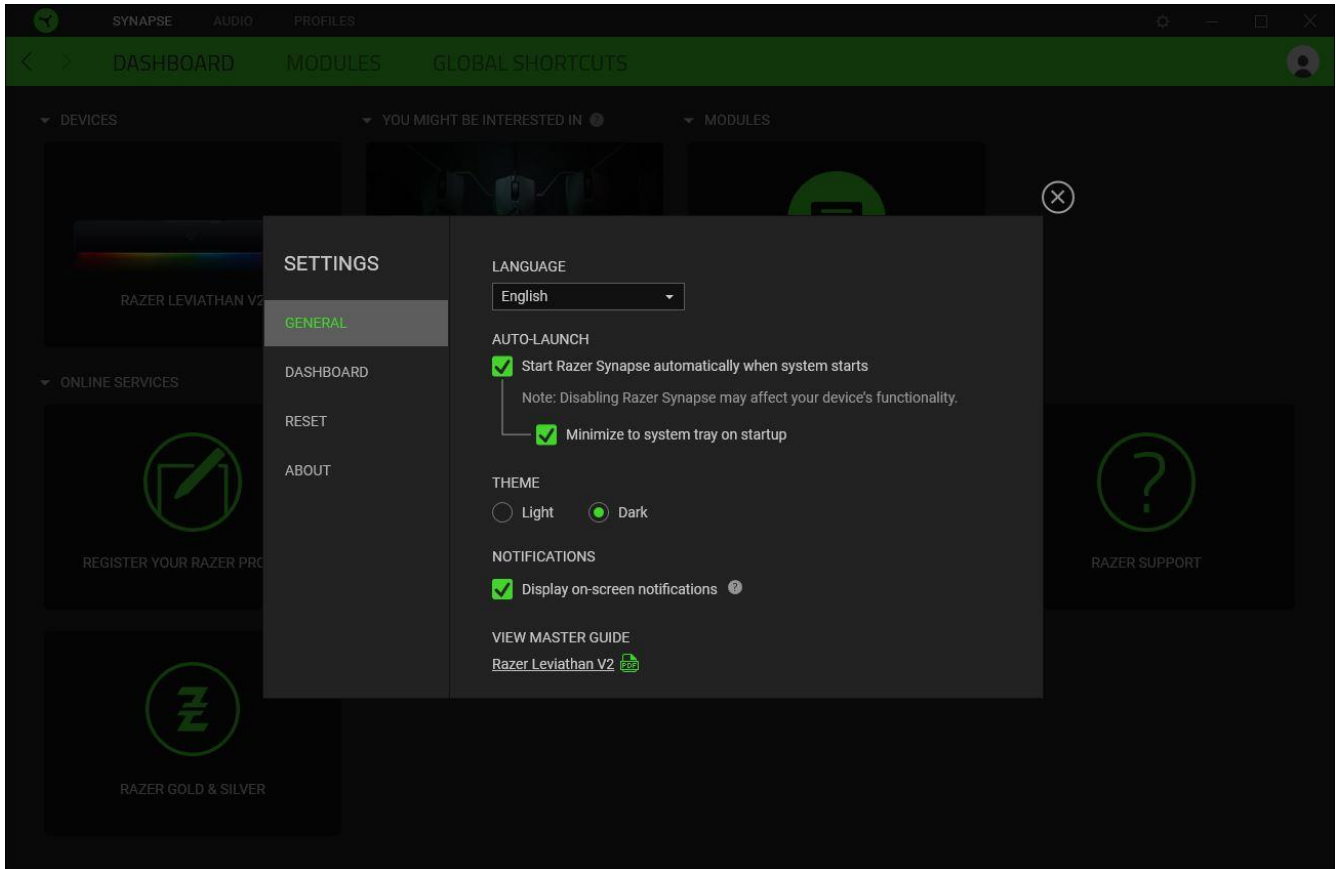

General tab

The General tab lets you change the software's display language, startup behavior, theme, and on-screen notifications display. You may also manually sync your profiles to the cloud (↻) or view the master guide of all connected Razer devices and installed modules.

Dashboard tab

Use the Dashboard tab to customize which Razer device recommendations based on your setup, and the games you play will appear on the Dashboard.

Reset tab

The Reset tab allows you to perform a factory reset on all connected Razer devices with on-board memory and/or reset Razer Synapse tutorials to acquaint yourself again with Razer Synapse's new features on its next launch.



All profiles stored on the selected device's on-board memory will be erased when you reset a Razer device.

About tab

The About tab displays brief software information and copyright statement, and provides relevant links for its terms of use. You may also use this tab to check for software updates, or as quick access to Razer's social communities.

7. SAFETY AND MAINTENANCE

SAFETY GUIDELINES

To achieve maximum safety while using your Razer Leviathan V2, we suggest that you adopt the following guidelines:

- Should you have trouble operating the device properly and troubleshooting does not work, unplug the device and contact the Razer hotline or go to support.razer.com for assistance.
- Do not take apart the device and do not attempt to operate it under abnormal current loads. Doing so will void your warranty.
- Keep the device away from liquid, humidity or moisture. Operate the device only within the specific temperature range of 0°C (32°F) to 40°C (104°F). Should the temperature exceed this range, unplug and/or switch off the device to stabilize the temperature to an optimal level.
- Listening to excessively loud volumes over extended periods can damage your hearing. Furthermore, legislation of certain countries permits a maximum sound level of 86db to affect your hearing for 8 hours a day. We, therefore, recommend that you reduce the volume to a comfortable level when listening for prolonged periods. Please, take good care of your hearing.

MAINTENANCE AND USE

The Razer Leviathan V2 requires minimum maintenance to keep it in optimum condition. Once a month, we recommend you clean the soundbar and its subwoofer using a soft cloth or cotton swab to prevent dirt buildup. Do not use soap or harsh cleaning agents.

8. LEGALESE

COPYRIGHT AND INTELLECTUAL PROPERTY INFORMATION

©2022 Razer Inc. All rights reserved. Razer, the triple-headed snake logo, Razer logo, and “For Gamers. By Gamers.” are trademarks or registered trademarks of Razer Inc. and/or affiliated companies in the United States or other countries. All other trademarks are the property of their respective owners.

Android, Google, Google Logo, Google Play, and the Google Play logo are registered trademarks of Google LLC.

Apple, the Apple logo, and iPhone are trademarks of Apple Inc., registered in the U.S. and other countries. App Store is a service mark of Apple Inc. iOS is a trademark or registered trademark of Cisco in the U.S. and other countries and is used under license.

The Bluetooth® word mark and logos are registered trademarks owned by Bluetooth SIG, Inc., and any use of such marks by Razer is under license.

THX and the THX Logo are the property of THX Ltd., registered in the U.S. and other countries.

Windows and the Windows logo are trademarks of the Microsoft group of companies.

Razer Inc. (“Razer”) may have copyright, trademarks, trade secrets, patents, patent applications, or other intellectual property rights (whether registered or unregistered) concerning the product in this guide. Furnishing of this guide does not give you a license to any such copyright, trademark, patent or other intellectual property right. The Razer Leviathan V2 (the “Product”) may differ from pictures whether on packaging or otherwise. Razer assumes no responsibility for such differences or for any errors that may appear. Information contained herein is subject to change without notice.

LIMITED PRODUCT WARRANTY

For the latest and current terms of the Limited Product Warranty, please visit [razer.com/warranty](https://www.razer.com/warranty).

LIMITATION OF LIABILITY

Razer shall in no event be liable for any lost profits, loss of information or data, special, incidental, indirect, punitive or consequential or incidental damages, arising in any way out of distribution of, sale of, resale of, use of, or inability to use the Product. In no event shall Razer’s liability exceed the retail purchase price of the Product.

GENERAL

These terms shall be governed by and construed under the laws of the jurisdiction in which the Product was purchased. If any term herein is held to be invalid or unenforceable, then such term (in so far as it is invalid or unenforceable) shall be given no effect and deemed to be excluded without invalidating any of the remaining terms. Razer reserves the right to amend any term at any time without notice.